

Dell™ 1707FP Flat Panel Color Monitor User's Guide

About Your Monitor

- [Front View](#)
- [Back View](#)
- [Side View](#)
- [Bottom View](#)
- [Monitor Specifications](#)
- [Caring for your Monitor](#)

Using Your Adjustable Monitor Stand

- [Attaching the Stand](#)
- [Organizing Your Cables](#)
- [Using the Tilt, Swivel, and Vertical Extension](#)
- [Removing the Stand](#)

Setting Up Your Monitor

- [Connecting Your Monitor](#)
- [Using the Front Panel](#)
- [Using the OSD](#)
- [Setting the Optimal Resolution](#)
- [Using the Dell Soundbar \(Optional\)](#)

Rotating Your Monitor

- [Changing the Rotation of Your Monitor](#)
- [Rotating Your Operating System](#)

Solving Problems

- [Troubleshooting Your Monitor](#)
- [General Problems](#)
- [Product Specific Problems](#)
- [USB Problems](#)
- [Troubleshooting Your Soundbar](#)

Appendix

- [FCC Identification Information](#)
- [Safety Information](#)
- [Contacting Dell](#)
- [Your Monitor Setup Guide](#)

Notes, Notices, and Cautions



NOTE: A NOTE indicates important information that helps you make better use of your computer.



NOTICE: A NOTICE indicates either potential damage to hardware or loss of data and tells you how to avoid the problem.



CAUTION: A CAUTION indicates a potential for property damage, personal injury, or death.

Information in this document is subject to change without notice.

© 2006 Dell Inc. All rights reserved.

Reproduction in any manner whatsoever without the written permission of Dell Inc. is strictly forbidden.

Trademarks used in this text: *Dell*, the *DELL* logo, *Inspiron*, *Dell Precision*, *Dimension*, *OptiPlex*, *Latitude*, *PowerEdge*, *PowerVault*, *PowerApp*, and *Dell OpenManage* are trademarks of Dell Inc.; *Microsoft*, *Windows*, and *Windows NT* are registered trademarks of Microsoft Corporation; *Adobe* is a trademark of Adobe Systems Incorporated, which may be registered in certain jurisdictions. *ENERGY STAR* is a registered trademark of the U.S. Environmental Protection Agency. As an ENERGY STAR partner, Dell Inc. has determined that this product meets the ENERGY STAR guidelines for energy efficiency.

Other trademarks and trade names may be used in this document to refer to either the entities claiming the marks and names or their products. Dell Inc. disclaims any proprietary interest in trademarks and trade names other than its own.

Model 1707FP

February 2006 Rev. A01

About Your Monitor

Dell™ 1707FP Flat Panel Color Monitor User's Guide

- [Front View](#)
- [Back View](#)
- [Bottom View](#)
- [Side View](#)
- [Monitor Specifications](#)
- [Caring for your Monitor](#)

Front View

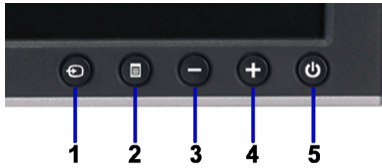

1.	Input select
2.	OSD menu / select button
3.	Down button
4.	Up button
5.	Power button (with power light indicator)

Back View

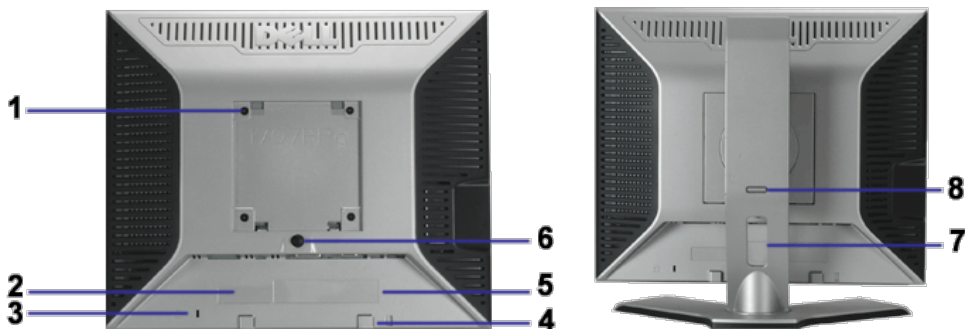

1	VESA mounting holes (100mm) (Behind attached base plate)	Use to mount the monitor.
2	Barcode serial number label	Refer to this label if you need to contact Dell for technical support.
3	Security lock slot	Use a security lock with the slot to help secure your monitor.
4	Dell Soundbar mounting brackets	Attach the optional Dell Soundbar.
5	Regulatory rating label	List the regulatory approvals.
6	Stand removal button	Press to release the stand

7	Cable holder	Help organize cables by placing them in the holder.
8	Lock down/release button	Push the monitor down, press the button to unlock the monitor, and then lift the monitor to the desired height.

Bottom View

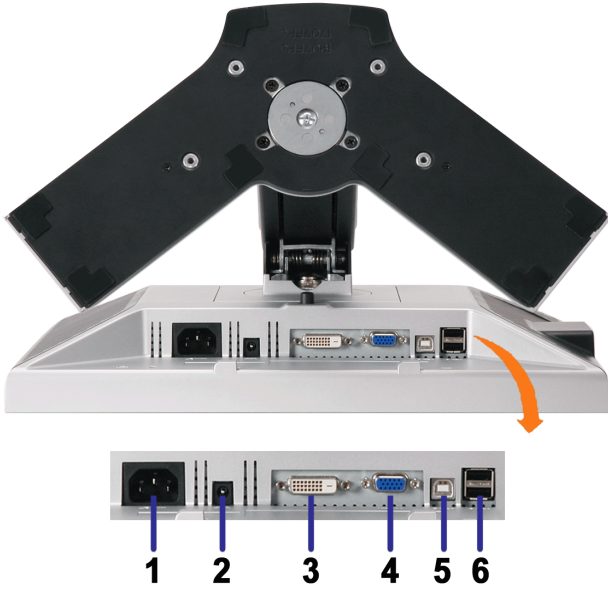

1	Power connector	Insert the power cable.
2	Dell Soundbar power connector	Connect the power cord for the Soundbar (optional).
3	DVI connector	Connect your computer DVI cable.
4	VGA connector	Connect your computer VGA cable.
5	USB upstream connector<	Connect the USB cable that came with your monitor to the monitor and the computer. Once this cable is connected you can use the USB connectors on the side and bottom of the monitor.
6	USB connector	Connect your USB devices.

NOTE: You can use this connector only after you connect the USB cable to the computer and the USB upstream connector on the monitor.

Side View

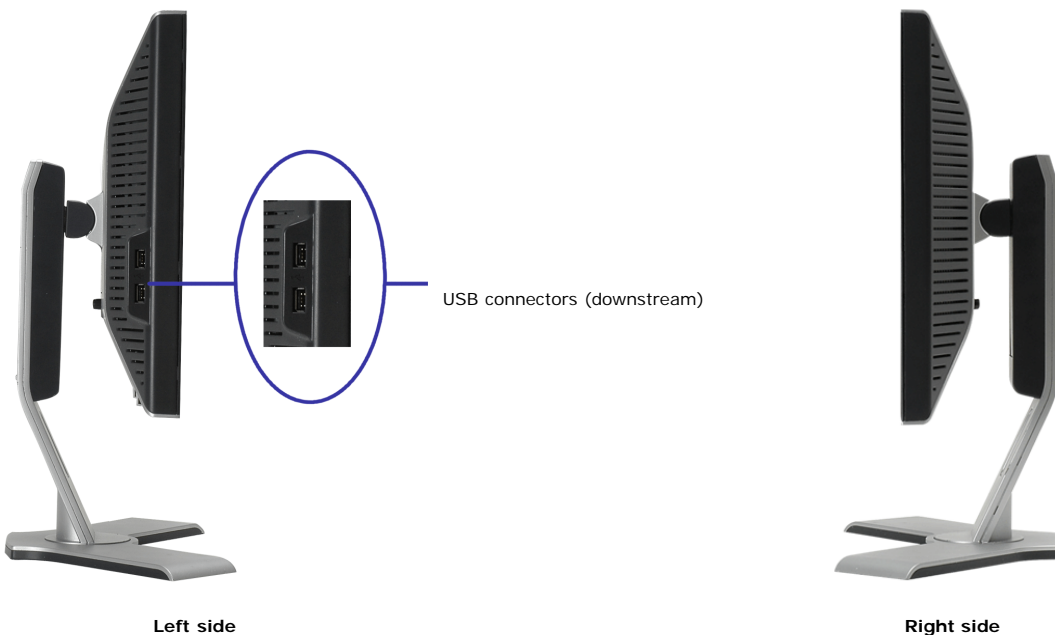

Monitor Specifications

Power Management Modes

If you have VESA's DPM™ compliance display card or software installed in your PC, the monitor can automatically reduce its power consumption when not in use. This is referred to as 'Power Save Mode'*. If input from keyboard, mouse, or other input devices is detected by the computer, the monitor automatically 'wakes up'. The following table shows the power consumption and signaling of this automatic power saving feature:

VESA Modes	Horizontal Sync	Vertical Sync	Video	Power Indicator	Power Consumption
Normal operation (with Dell Soundbar and USB active)	Active	Active	Active	Green	75 W (maximum)
Normal operation	Active	Active	Active	Green	32 W (typical)
Active-off mode	Inactive	Inactive	Blanked	Amber	Less than 2 W
Switch off	-	-	-	Off	Less than 1 W



NOTE: The OSD will only function in the 'normal operation' mode. One of the following messages will appear when the "menu" or "plus" buttons are pressed when in Active-off mode.

1. Analog Input
In Power Save Mode
Press Computer Power Button
or Any Key on Keyboard or Move Mouse

or

2. Digital Input
In Power Save Mode
Press Computer Power Button
or Any Key on Keyboard or Move Mouse

Activate the computer and 'wake up' the monitor to gain access to the [OSD](#).

This monitor is **ENERGY STAR**®-compliant as well as TCO '99 / TCO '03 power management compatible.



* Zero power consumption in OFF mode can only be achieved by disconnecting the main cable from the monitor.

Pin Assignments

15-pin D-Sub connector

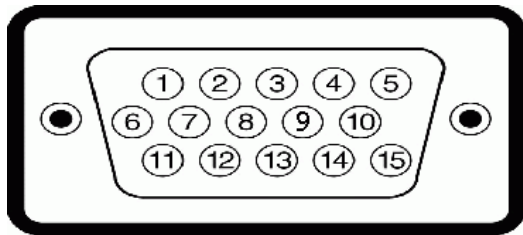

Pin Number	Monitor Side of the 15-pin Side Signal Cable
1	Video-Red
2	Video-Green
3	Video-Blue
4	GND
5	Self-test
6	GND-R
7	GND-G
8	GND-B
9	DDC +5V
10	GND-sync
11	GND
12	DDC data
13	H-sync
14	V-sync
15	DDC clock

24-pin Digital-only DVI Connector

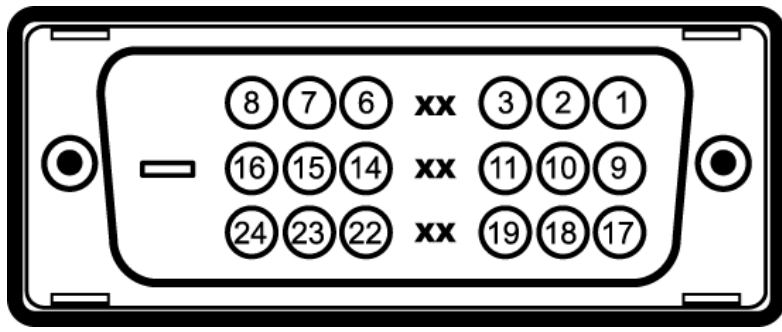

Note: Pin 1 is at the top right.

Pin	Signal Assignment	Pin	Signal Assignment	Pin	Signal Assignment
1	T.M.D.S. Data 2-	9	T.M.D.S. Data 1-	17	T.M.D.S. Data 0-
2	T.M.D.S. Data 2+	10	T.M.D.S. Data 1+	18	T.M.D.S. Data 0+
3	T.M.D.S. Data 2 Shield	11	T.M.D.S. Data 1 Shield	19	T.M.D.S. Data 0 Shield
4	No Pin	12	No Pin	20	No Pin
5	No Pin	13	No Pin	21	No Pin
6	DDC Clock	14	+5V Power	22	T.M.D.S. Clock Shield
7	DDC Data	15	Ground (for +5V)	23	T.M.D.S. Clock +
8	No Connect	16	Hot Plug Detect	24	T.M.D.S. Clock -

Universal Serial Bus (USB) Interface

This monitor supports High-Speed Certified USB 2.0 interface.



	Data Rate	Power Consumption
High speed	480 Mbps	2.5W (Max., each port)
Full speed	12 Mbps	2.5W (Max., each port)
Low speed	1.5 Mbps	2.5W (Max., each port)

USB ports:

- 1 upstream - rear
- 4 downstream - 2 on rear; 2 on left side

NOTE: USB 2.0 capability requires 2.0-capable computer.

NOTE: The USB interface of the monitor works ONLY when monitor is powered ON (or in Power Save Mode). Switching your monitor OFF and then ON would re-enumerate its USB interface; attached peripherals may take a few seconds to resume normal functionality.

Plug and Play Capability

You can install the monitor in any Plug and Play-compatible system. The monitor automatically provides the computer system with its Extended Display Identification Data (EDID) using Display Data Channel (DDC) protocols so that the system can configure itself and optimize the monitor settings. If desired, you can select different settings, but in most cases monitor installation is automatic.

General

Model number 1707FP

Flat Panel

Screen type	Active matrix - TFT LCD
Screen dimensions	17 inches (17-inch viewable image size)
Preset display area:	
Horizontal	337 mm (13.3 inches)
Vertical	270 mm (10.6 inches)
Pixel pitch	0.264 mm
Viewing angle	130° (vertical) typ, 140° (horizontal) typ
Luminance output	300 CD/m ² (typ)
Contrast ratio	600 to 1 (typ)>
Faceplate coating	Antiglare with hard-coating 3H
Backlight	CCFL (4) edgelight system

Response Time

8ms typical

Resolution

Horizontal scan range	30 kHz to 81 kHz (automatic)
Vertical scan range	56 Hz to 76 Hz (automatic)
Optimal preset resolution	1280 x 1024 at 60 Hz
Highest preset resolution	1280 x 1024 at 75 Hz

Preset Display Modes

Display Mode	Horizontal Frequency (kHz)	Vertical Frequency (Hz)	Pixel Clock (MHz)	Sync Polarity (Horizontal/Vertical)
VESA, 720 x 400	31.5	70.0	28.3	-/+
VESA, 640 x 480	31.5	60.0	25.2	-/-
VESA, 640 x 480	37.5	75.0	31.5	-/-
VESA, 800 x 600	37.9	60.3	49.5	+/+
VESA, 800 x 600	46.9	75.0	49.5	+/+
VESA, 1024 x 768	48.4	60.0	65.0	-/-
VESA, 1024 x 768	60.0	75.0	78.8	+/+
VESA, 1152 x 864	67.5	75.0	108	+/+
VESA, 1280 x 1024	64.0	60.0	135.0	+/+
VESA, 1280 x 1024	80.0	75.0	135.0	+/+

Electrical

Video input signals	Analog RGB, 0.7 Volts +/-5%, positive polarity at 75 ohm input impedance Digital DVI-D TMDS, 600mV for each differential line, positive polarity at 50 ohm input impedance
Synchronization input signals	Separate horizontal and vertical synchronizations, polarity-free TTL level, SOG (Composite SYNC on green)
AC input voltage / frequency / current	100 to 240 VAC / 50 or 60 Hz \pm 3 Hz / 2.0A (Max.)
Inrush current	120V: 42A (Max.) 240V: 80A (Max.)

Physical Characteristics

Connector type	15-pin D-subminiature, blue connector; DVI-D, white connector
Signal cable type	Digital: Detachable, DVI-D, Solid pins, shipped detached from the monitor Analog: Detachable, D-Sub, 15pins, shipped attached to the monitor

Dimensions (with stand):

Height (Compressed)	12.90 inches (327.62 mm)
Height (Extended)	18.02 inches (457.62 mm)
Width	14.64 inches (371.81 mm)
Depth	7.16 inches (181.90 mm)

Dimensions: (without stand)

Height	12.18 inches (309.25 mm)
Width	14.64 inches (371.81 mm)
Depth	2.57 inches (65.36 mm)

Stand dimensions:

Height (Compressed)	12.90 inches (327.66 mm)
Height (Extended)	14.65 inches (372.20 mm)
Width	13.27 inches (337.00 mm)
Depth	7.16 inches (181.90 mm)
Weight with packaging	16.98 lbs (7.70 kg)
Weight with stand assembly and cables	13.23 lbs (6.00 kg)
Weight without stand assembly (For wall mount or VESA mount considerations - no cables)	9.13 lbs (4.14 kg)
Weight of stand assembly	3.31 lbs (1.5 kg)

Environmental

Temperature:

Operating	5° to 35°C (41° to 95°F)
Nonoperating	Storage: -20° to 60°C (-4° to 140°F) Shipping: -20° to 60°C(-4° to 140°F)

Humidity:

Operating	10% to 80% (noncondensing)
Nonoperating	Storage: 5% to 90% (noncondensing) Shipping: 5% to 90%(noncondensing)

Altitude:

Operating	3,657.6m (12,000 ft) max
Nonoperating	12,192 m (40,000 ft) max

Thermal dissipation

256.08 BTU/hour (maximum)
119.5 BTU/hour (typical)

Caring for your Monitor

 **CAUTION:** Read and follow the [safety instructions](#) before cleaning the monitor.

 **CAUTION:** Before cleaning the monitor, unplug the monitor power cable from the electrical outlet.

- To clean your antistatic screen, lightly dampen a soft, clean cloth with water. If possible, use a special screen-cleaning tissue or solution suitable for the antistatic coating. Do not use benzene, thinner, ammonia, abrasive cleaners, or compressed air.
 - Use a lightly-dampened, warm cloth to clean the plastics. Avoid using detergent of any kind as some detergents leave a milky film on the plastics.
 - If you notice a white powder when you unpack your monitor, wipe it off with a cloth. This white powder occurs during the shipping of the monitor.
 - Handle your monitor with care as darker-colored plastics may scratch and show white scuff marks more than lighter-colored monitor.
 - To help maintain the best image quality on your monitor, use a dynamically changing screen saver and power off your monitor when not in use.
-

[Back to Contents Page](#)

Using Your Adjustable Monitor Stand

Dell™ 1707FP Flat Panel Color Monitor User's Guide

- [Attaching the Stand](#)
 - [Organizing Your Cables](#)
 - [Using the Tilt, Swivel, and Vertical Extension](#)
 - [Removing the Stand](#)
-

Attaching the Stand

 **NOTE:** The stand is detached and extended when the monitor is shipped from the factory.

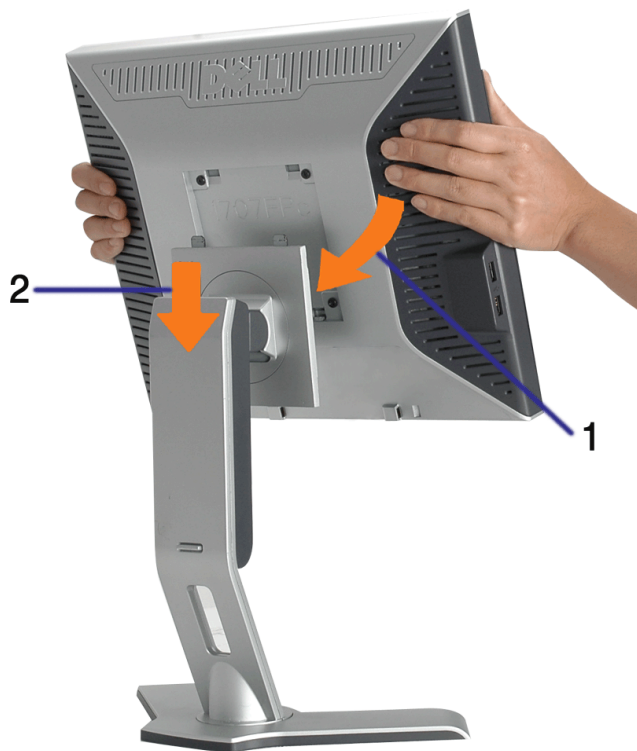

1. Fit the groove on the monitor to the two tabs on the stand.
 2. Lower the monitor until it locks in to place on the stand.
-

Organizing Your Cables

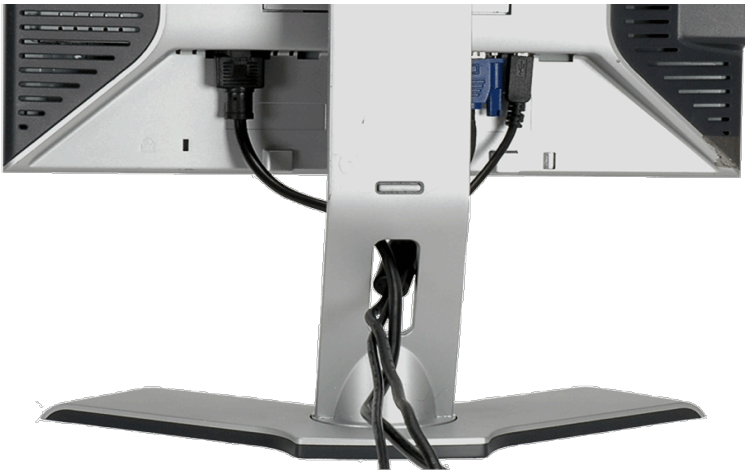

After attaching all necessary cables to your monitor and computer, (See [Connecting Your Monitor](#) for cable attachment,) use the cable holder to neatly organize all cables as shown above.

Using the Tilt, Swivel, and Vertical Extension

Adjusting Your Monitor Using Tilt, Swivel, and Vertical Extension. You can adjust your monitor to best fit your viewing needs.

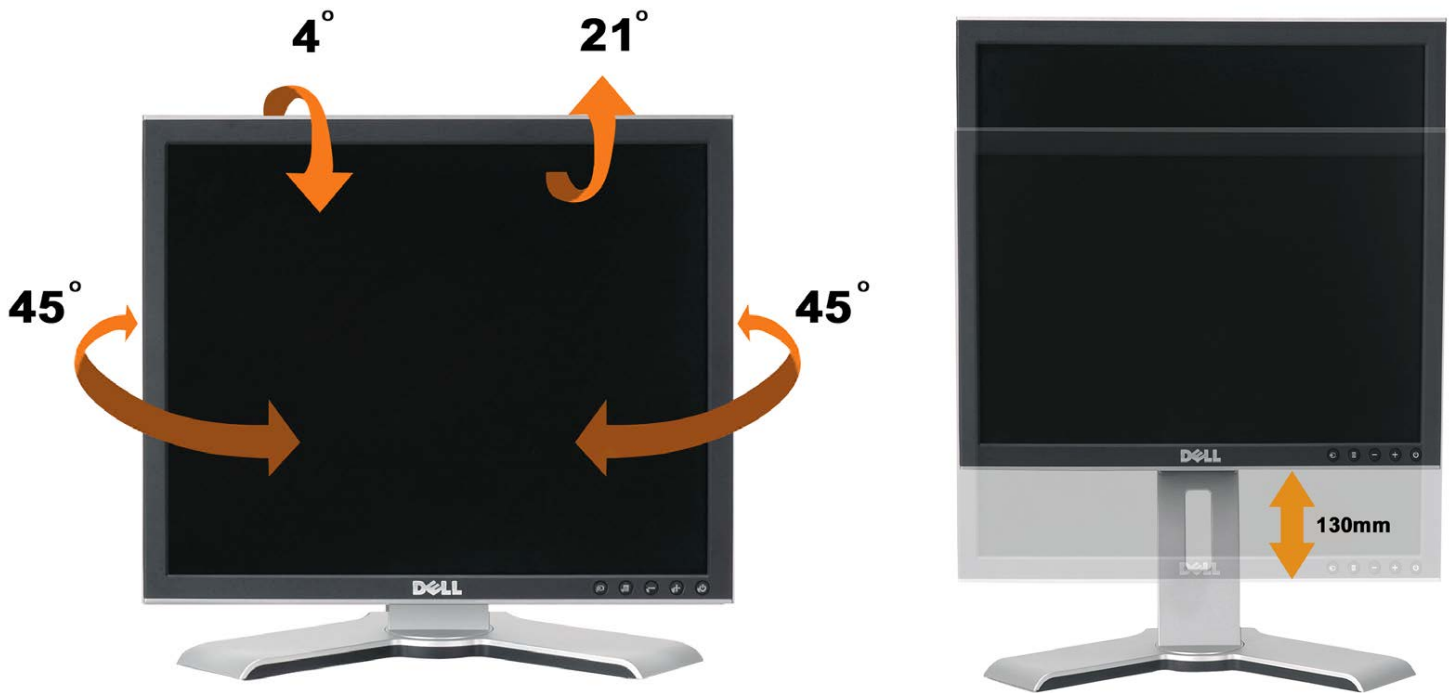

You can adjust the stand vertically, up to 5.12 inches (130mm) using the stand lock/release button. You can adjust the monitor to the desired position by sliding the monitor up and down the Stand. .

 **NOTE:** Before you move the monitor to a new location, lock the stand by lowering monitor until it clicks in to place.

Removing the Stand

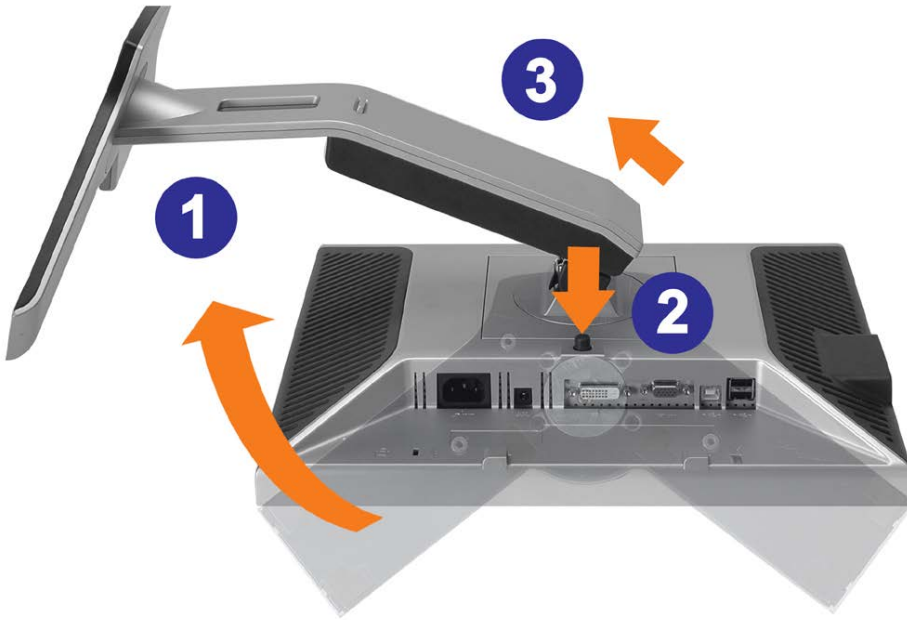

⬅ **NOTICE:** After placing the monitor panel on soft cloth or cushion, complete the following steps to remove the stand.

1. Rotate the stand to allow access to the stand release button.
2. Press the Stand release button and lift up the Stand and away from the monitor .

[Back to Contents Page](#)

Setting Up Your Monitor

Dell™ 1707FP Flat Panel Color Monitor User's Guide

- [Connecting Your Monitor](#)
- [Using the Front Panel](#)
- [Using the OSD Menu](#)
- [Setting the Optimal Resolution](#)
- [Using the Dell Soundbar \(Optional\)](#)

Connecting Your Monitor

 **CAUTION:** Before you begin any of the procedures in this section, follow the [safety instructions](#).

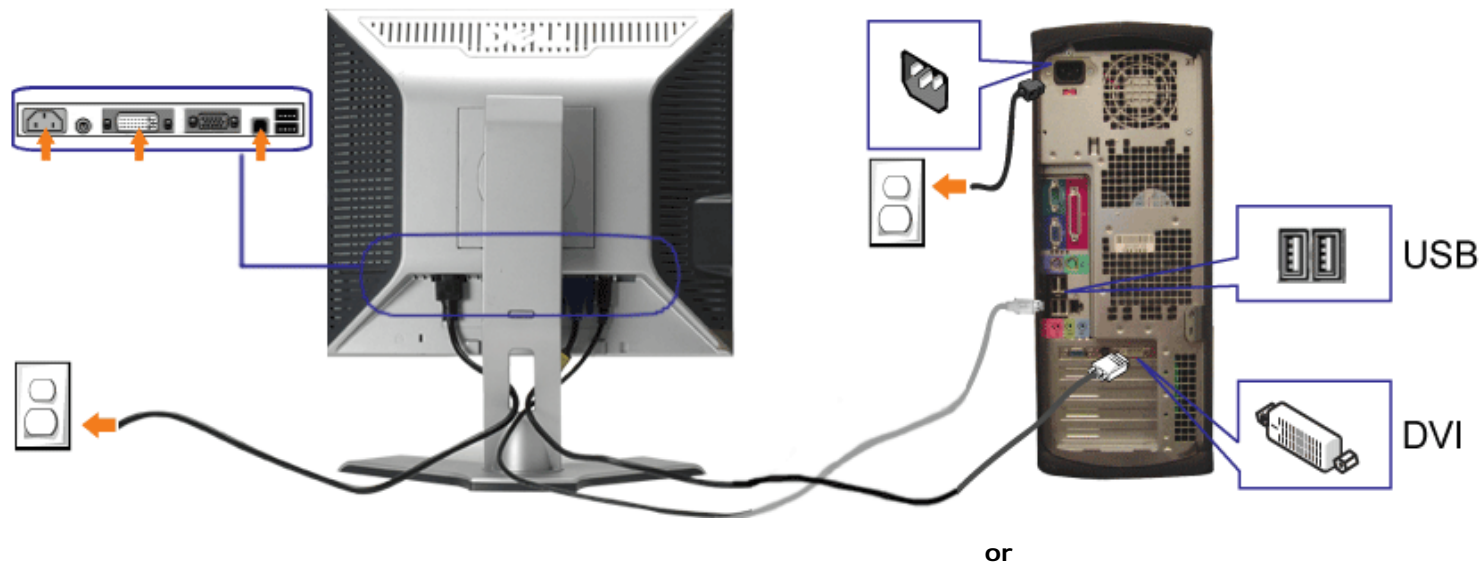

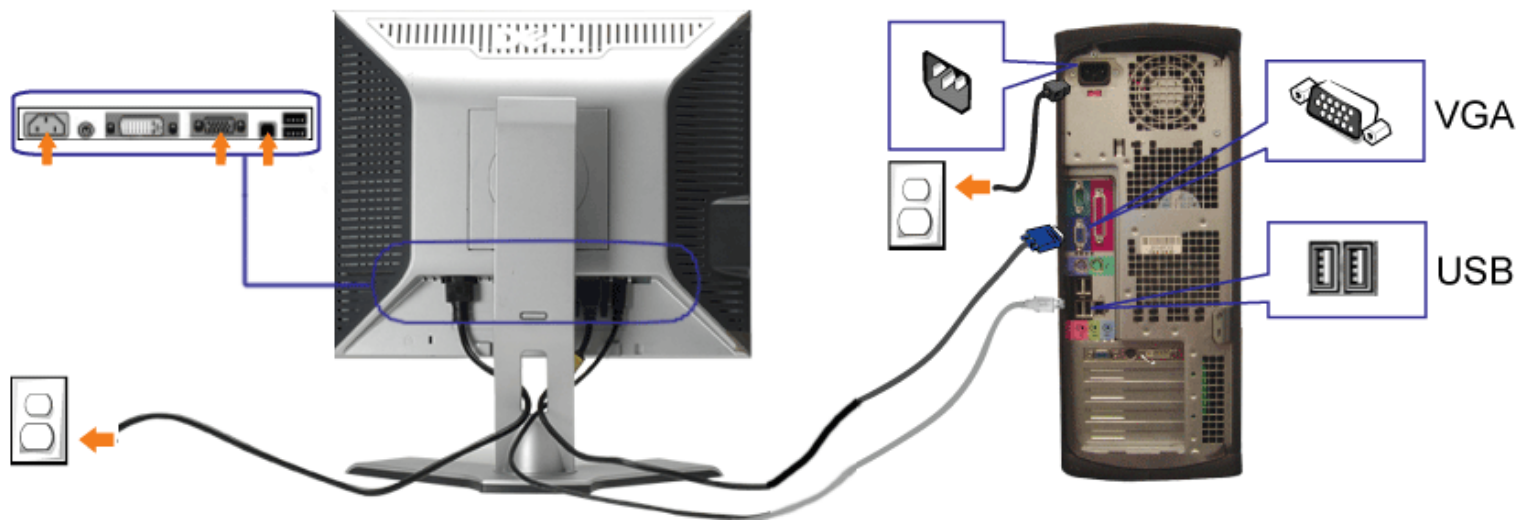

1. Turn off your computer and disconnect the power cable.
2. Connect either the white DVI or blue VGA cables to the connectors on the computer and the monitor.
3. Connect the USB cable that was included with your monitor to the computer and the upstream USB connector on the monitor. Once this cable is connected to the computer and the monitor, you can use the USB connectors on the monitor.
4. Connect any USB devices.
5. Connect the power cables
6. Turn on your monitor and computer. If you do not see an image, push the input select button and ensure the correct input source is selected. If you still do not see an image, see [Troubleshooting your monitor](#).

Using the Front Panel

Use the buttons on the front of the monitor to adjust the image settings.

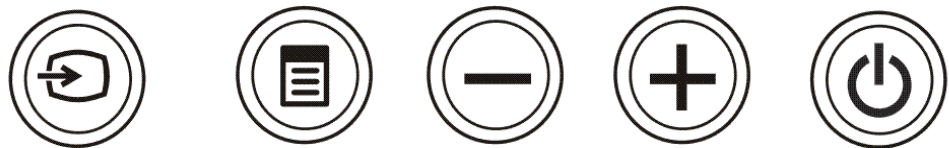

A

B

C

D

E



Input select

Use the Input Select button to select between two different video signals that may be connected to your monitor.



NOTE: The floating 'Dell Self-test Feature Check' dialog appears on a black background if the monitor cannot sense a video signal. Using the input select button, select the desired input to be tested either Analog Input or Digital Input. Disconnect the video cable from the video card and the Dell Self-test Feature Check dialogue box will appear if the display is operating correctly.

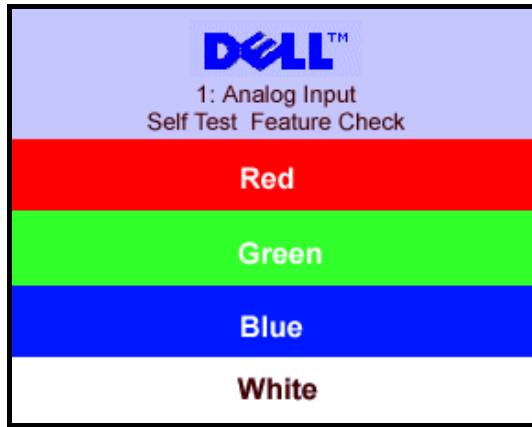

or

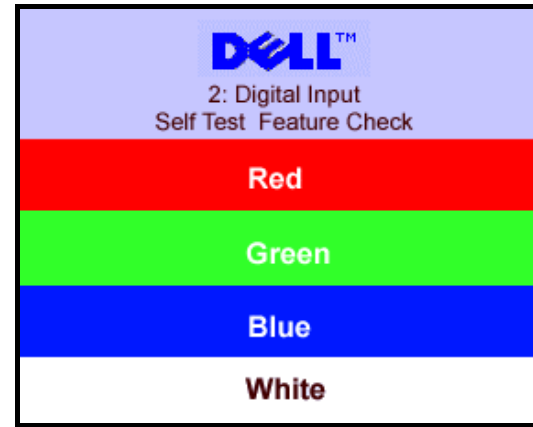

OSD menu / select

The Menu button is used to open and exit the on-screen display (OSD), and exit from menus and sub-menus. See [Using the OSD Menu](#).

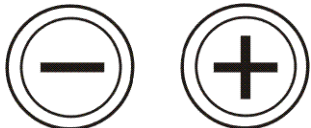

Down (-) and Up (+)

Use these buttons to adjust (decrease/increase ranges) items in the OSD menu.



Power Button and Indicator

Use the power button to turn the monitor on and off.

The green light indicates the monitor is on, and fully functional. An amber light indicates power save mode.

Using the OSD Menu



NOTE: If you change the settings and then either proceed to another menu, or exit the OSD menu, the monitor automatically saves those changes. The changes are also saved if you change the settings and then wait for the OSD menu to disappear.

1. Push the MENU button to open the OSD menu and display the main menu.

Main Menu for Analog (VGA) Input

Main Menu for Digital (DVI) Input

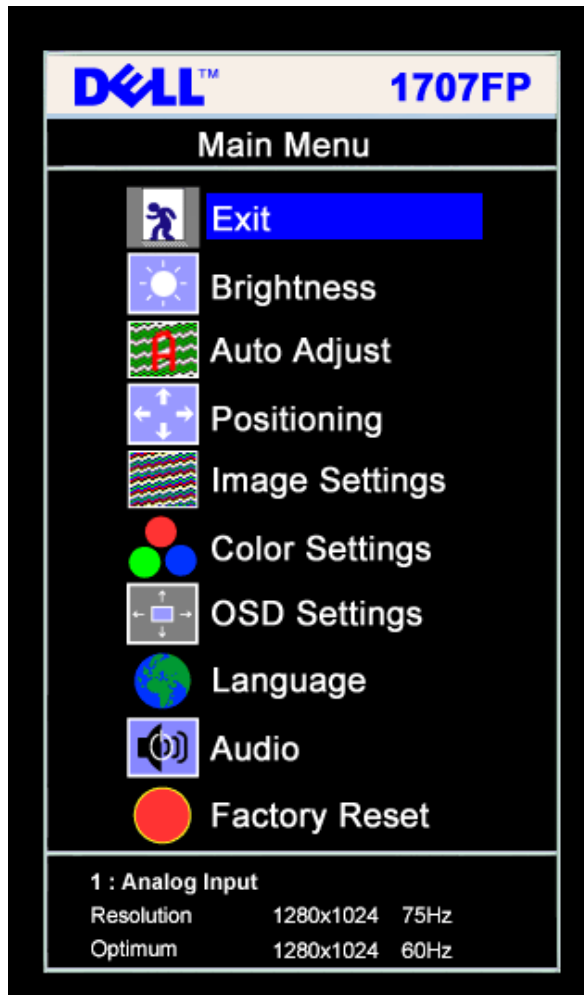

or

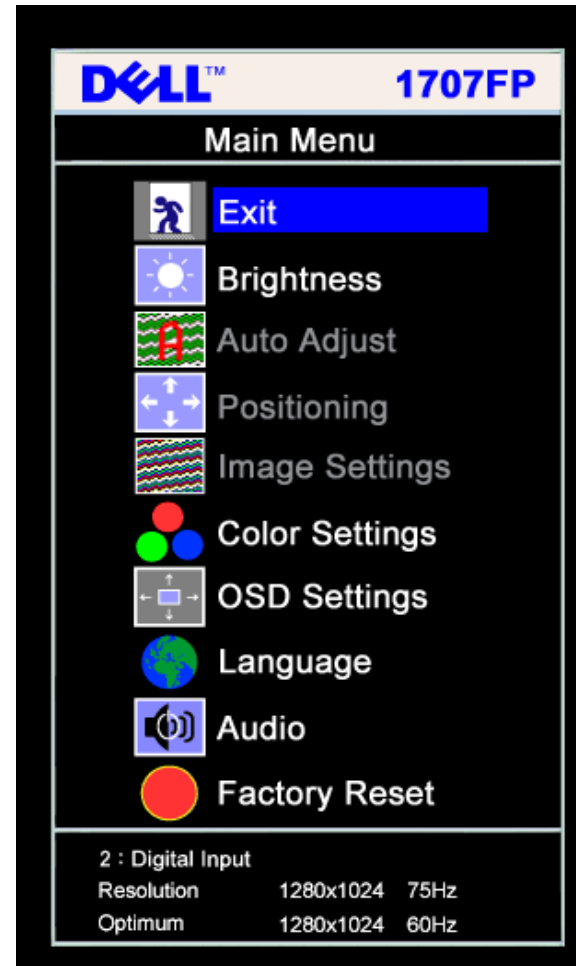

NOTE: Auto Adjust, Positioning and Image Settings are only available when you are using the analog (VGA) connector.

2. Push the - and + buttons to move between the setting options. As you move from one icon to another, the option name is highlighted. See the table below for a complete list of all the options available for the monitor.
3. Push the MENU button once to activate the highlighted option.
4. Push - and + button to select the desired parameter.
5. Push MENU to enter the slide bar and then use the - and + buttons, according to the indicators on the menu, to make your changes.
6. Push the MENU button once to return to the main menu to select another option or push the MENU button two or three times to exit from the OSD menu.

Icon	Menu and Submenus	Description
	Exit	Select to exit the Main menu
	Brightness/	Brightness adjusts the luminance of the backlight.



Contrast

Adjust **Brightness** first, then adjust **Contrast** only if further adjustment is necessary.

Push the + button to increase luminance and push the - button to decrease luminance (min 0 ~ max 100).

Contrast adjusts the degree of difference between darkness and lightness on the monitor screen.

Push the + button to increase the contrast and push the - button to decrease the contrast (min 0 ~ max 100).

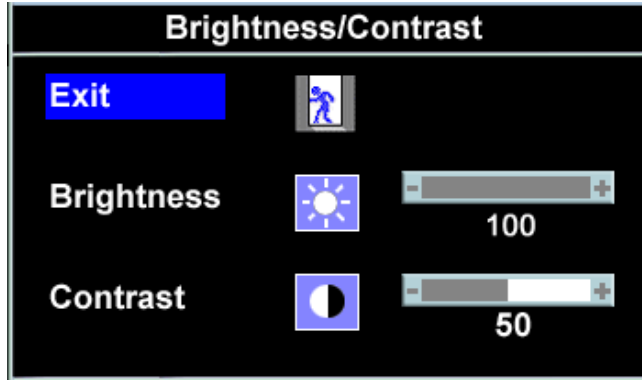

NOTE: When using DVI source, the contrast adjustment is not available.



Positioning: Horizontal Vertical

Positioning moves the viewing area around on the monitor screen.

When making changes to either the Horizontal or Vertical settings, no changes occur to the size of the viewing area. The image shifts in response to your selection.

Minimum is 0 (-) and maximum is 100 (+).

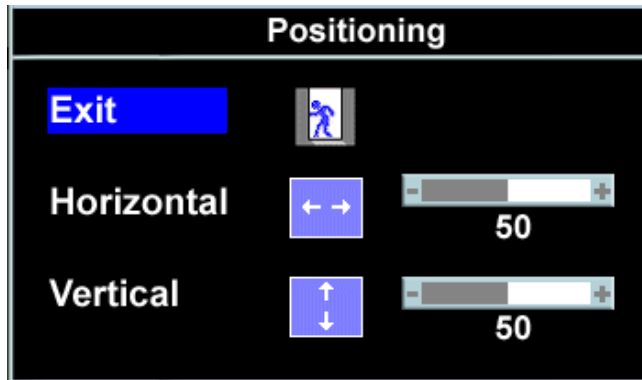

NOTE: When using DVI source, the Positioning option is not available.



Auto Adjust

Even though your computer recognizes your monitor on startup, the Auto Adjustment function optimizes the display settings for use with your particular setup.

Select to activate automatic setup and adjustment. The following dialog appears on a black screen as the monitor self-adjusts to the

current input:



Auto Adjustment allows the monitor to self-adjust to the incoming video signal. After using Auto Adjustment, you can further tune your monitor by using the Pixel Clock (Coarse) and Phase (Fine) controls under Image Settings.

 **In most cases, Auto Adjust produces the best image for your configuration.**



Image settings:

Pixel Clock (Coarse)

Phase (Fine)

The Phase and Pixel Clock adjustments allow you to more closely adjust your monitor to your preference. These settings are accessed through the main OSD menu, by selecting Image Settings.

Use the - and + buttons to make adjustments. (Minimum: 0 ~ Maximum: 100)

If satisfactory results are not obtained using the Phase adjustment, use Pixel Clock (Coarse) and then use Phase (fine), again.

 **NOTE: This function may change the width of the display image. Use the Horizontal function of the Position menu to center the display image on the screen.**

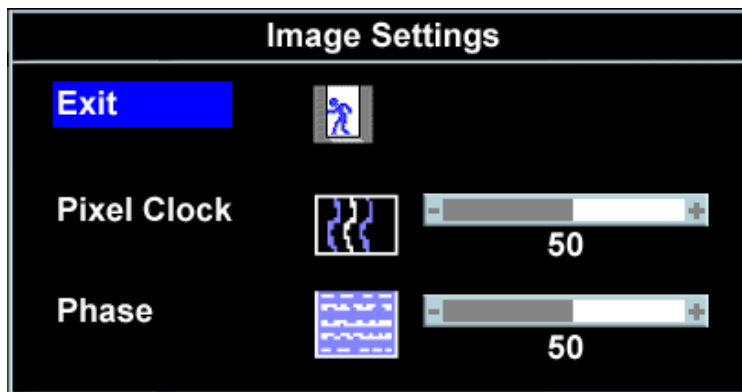

 **NOTE: When using DVI source, the Image Settings option is not available.**



Color Settings

Color Settings adjusts the color temperature, color hue, and saturation.

The color hue is most noticeable in areas of white.

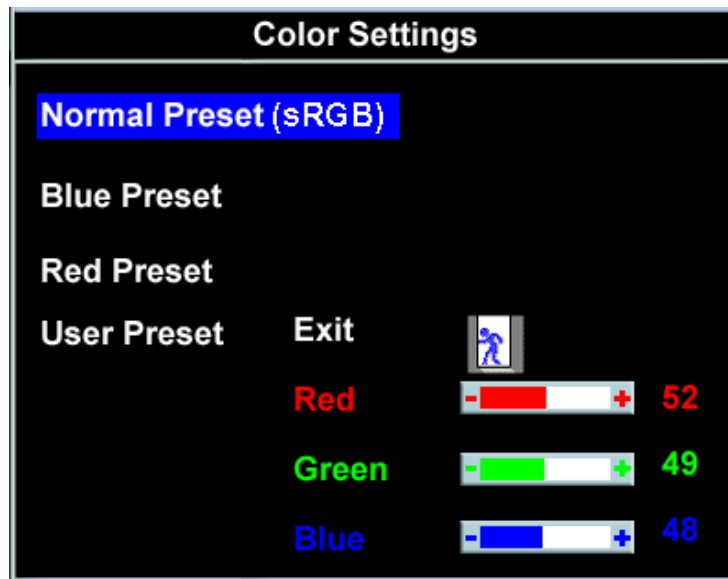

Blue Preset

Red Preset

Normal Preset

User Preset

- Blue Preset is selected to obtain a bluish tint. This color setting is typically used for text based applications (spreadsheets, programming, text editors, etc.).
- Red Preset is selected to obtain a redder tint. This color setting is typically used for color-intensive applications (photograph image editing, multimedia, movies, etc.).
- Normal Preset is selected to obtain the default (factory) color settings. This setting is also the “sRGB” standard default color space.
- User Preset: Use the plus and minus buttons to increase or decrease each of the three colors (R, G, B) independently, in single digit increments, from 0 to 100.



OSD Settings:

Horizontal Position

Vertical Position

OSD Hold Time

OSD Lock

Adjust the settings for the OSD, including the location, the amount of time the menu remains on-screen, and the rotation of the OSD.

Position of the OSD:

- To adjust the horizontal position of the OSD, use the - and + buttons, and move OSD to the left and right.
- To adjust the vertical position of the OSD, use the - and + buttons, and move OSD down and up.

OSD Hold Time:

The OSD stays active for as long as it is in use. Adjusting the hold time, sets the length of time the OSD remains active after the last time you pressed a button. Use the - and + buttons to adjust the slider in 5 second increments, from 5 to 60 seconds.

OSD Lock:

Controls user access to adjustments. When Yes (+) is selected, no user adjustments are allowed. All buttons are locked except the menu button.



NOTE: When the OSD is locked, pressing the menu button takes the user directly to the OSD settings menu, with OSD Lock selected. Select No (-) to unlock and allow user access to all applicable settings.

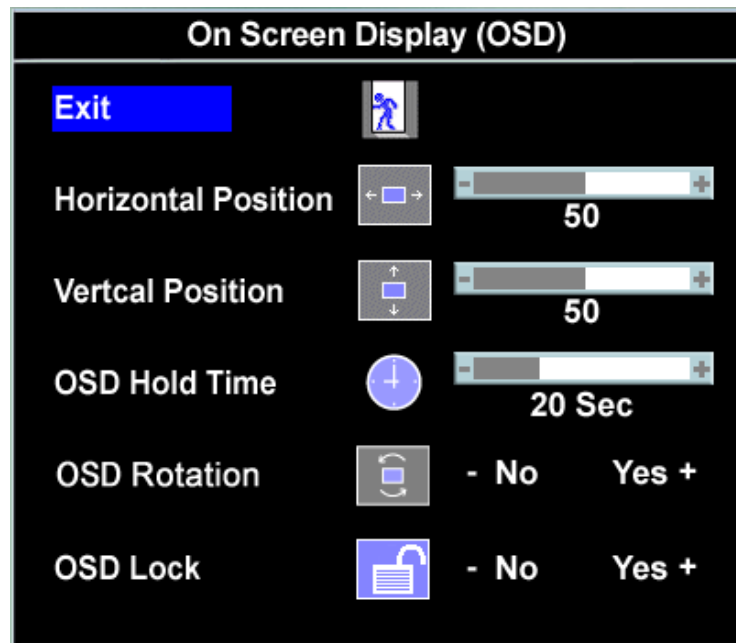

 **NOTE:** You can also lock or unlock the OSD by pushing and holding the Menu button for 15 seconds.



Language

Select to have the OSD display in one of five languages (English, French, Spanish, German, or Japanese).



 **NOTE:** The change only affects the OSD. It has no effect on any software running on the computer.



Audio (optional)

You can select to have the audio on or off when the monitor is in power saving mode.

Yes — enables audio

No — disables audio (default)

Audio On During Power Saving



No -



Yes +



NOTE: When the Dell Soundbar is not properly connected to the monitor, the audio menu is not available.



Factory Reset:

Reset the OSD menu options to the factory preset values.

Reset to Factory Settings



Exit



Position Settings Only



Color Settings Only



All Settings

DDC/CI

- Enable

Disable +

Exit — Select to exit out of Reset to Factory Settings menu without resetting any OSD options.

Position Settings Only — Change the settings for Image Position back to original factory settings.

Color Settings Only — Change the Red, Green, and Blue settings back to their original factory settings and set the default setting for Normal Preset.

All Settings — Change all the user-adjustable settings including color, position, brightness, contrast and OSD hold time to the factory defaults. The language of the OSD does not change.

DDC/CI — Enable the DDC/CI control function.

DDC/CI (Display Data Channel/Command Interface) allows your monitor parameters (brightness, color balance etc) to be adjustable via software on your PC.

Default is "Enable". You can disable this feature by selecting "Disable".

For best user experience and optimum performance of your monitor, keep this feature enabled.



NOTE: If user select "Disable", display Warning message box as below. Select "Yes" disable DDC/CI and return to "Reset to Factory Settings" menu. Warning message time-out in 20 sec.

The function of adjusting display settings using PC applications will be disabled.

Do you want to disable DDC/CI?

OSD Warning Messages

One of the following warning messages may appear on the screen indicating that the monitor is out of synchronization.

Optimum Resolution 1280 x1024 60Hz

or

Optimum Resolution 1280 x1024 60Hz

This means that the monitor cannot synchronize with the signal that it is receiving from the computer. Either the signal is too high or too low for the monitor to use. See [Specifications](#) for the Horizontal and Vertical frequency ranges addressable by this monitor. Recommended mode is 1280 X 1024 @ 60Hz.

 **NOTE: The floating Dell Self-test Feature Check dialog appears on-screen if the monitor cannot sense a video signal.**

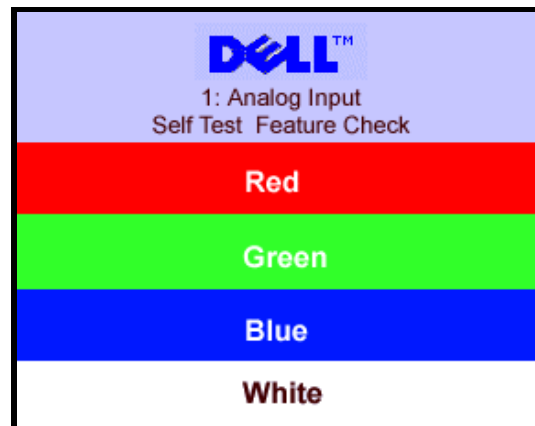

or

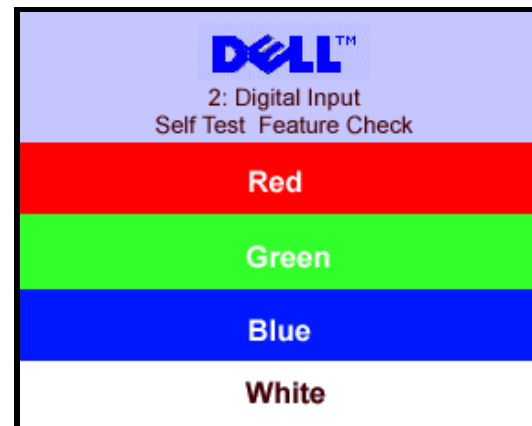

Occasionally, no warning message appears, but the screen is blank. This could also indicate that the monitor is not synchronizing with the computer.

See [Solving Problems](#) for more information.

Setting the Optimal Resolution

1. Right-click on the desktop and select **Properties**.
2. Select the **Settings** tab.
3. Set the screen resolution to 1280 x 1024.
4. Click **OK**.

If you do not see 1280 x 1024 as an option, you may need to update your graphics driver. Depending on your computer, complete one of the following procedures.

If you have a Dell desktop or portable computer:

- Go to **support.dell.com**, enter your service tag, and download the latest driver for your graphics card.

If you are using a non-Dell computer (portable or desktop):

- Go to the support site for your computer and download the latest graphic drivers.
- Go to your graphics card website and download the latest graphic drivers.

Using the Dell Soundbar (Optional)

The Dell Sound Bar is a stereo two channel system adaptable to mount on Dell Flat Panel Displays. The Sound Bar has a rotary volume and on/off control to adjust the overall system level, a blue LED for power indication, and two audio headset jacks.

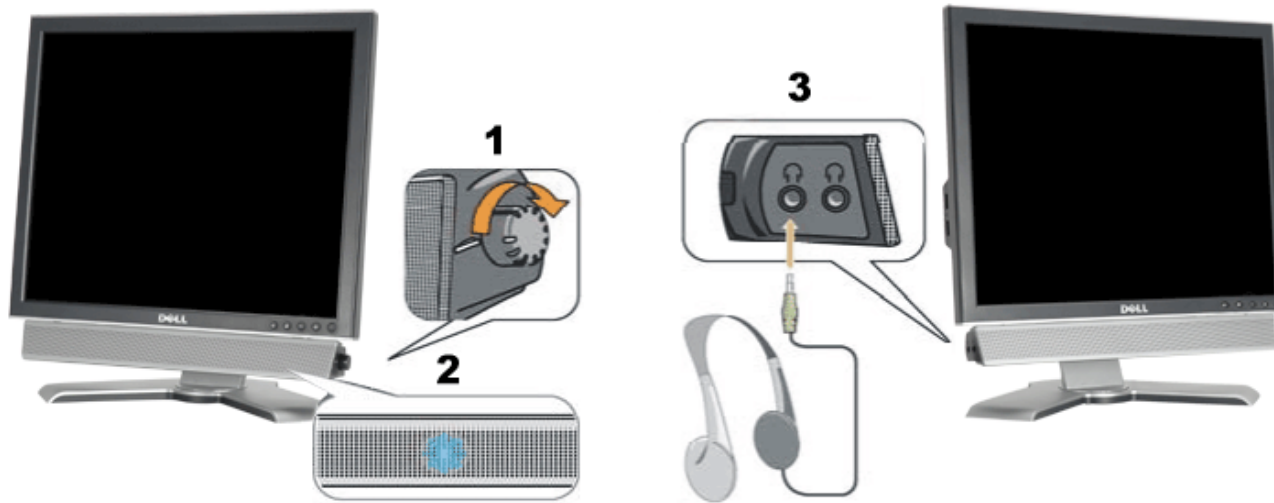

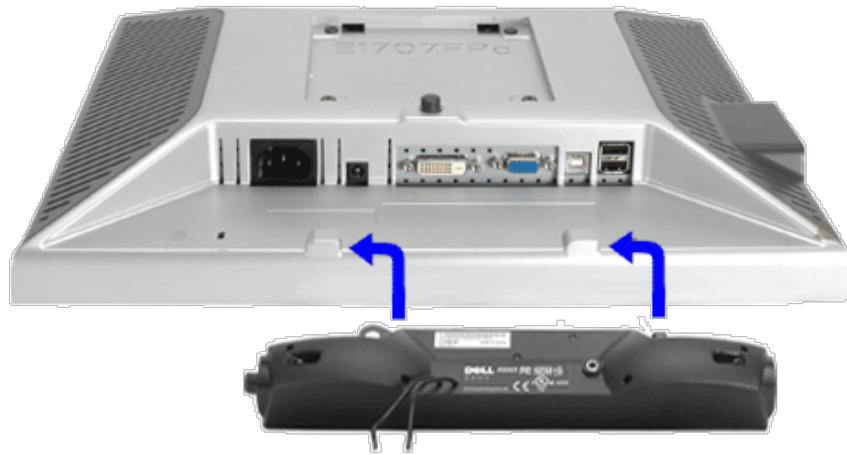

1. Power/volume control
2. Power indicator
3. Headphone connectors

Soundbar Attachment to the Monitor



1. Working from the rear of the monitor, attach the Sound Bar aligning the two slots with the two tabs along the bottom rear of the monitor.
2. Slide the Sound Bar to the left until it snaps into place.
3. Plug in the power cord from the Soundbar in to the connector on the back of the monitor.
4. Insert the lime-green mini stereo plug from the rear of the Sound Bar into the computer's audio output jack.

 **NOTE:** *Sound Bar Power Connector - 12V DC output is for optional Dell Sound Bar only.*

 **NOTICE:** *Do not use with any device other than Dell Sound Bar.*

[Back to Contents Page](#)

Rotating Your Monitor

Dell™ 1707FP Flat Panel Color Monitor User's Guide

- [Changing the Rotation of Your Monitor](#)
- [Rotating Your Operating System](#)

Changing the Rotation of Your Monitor

Before you rotate the monitor, your monitor should either be vertically extended ([Vertical Extension](#)) or tilted ([Tilt](#)) to avoid hitting the bottom edge of the monitor.

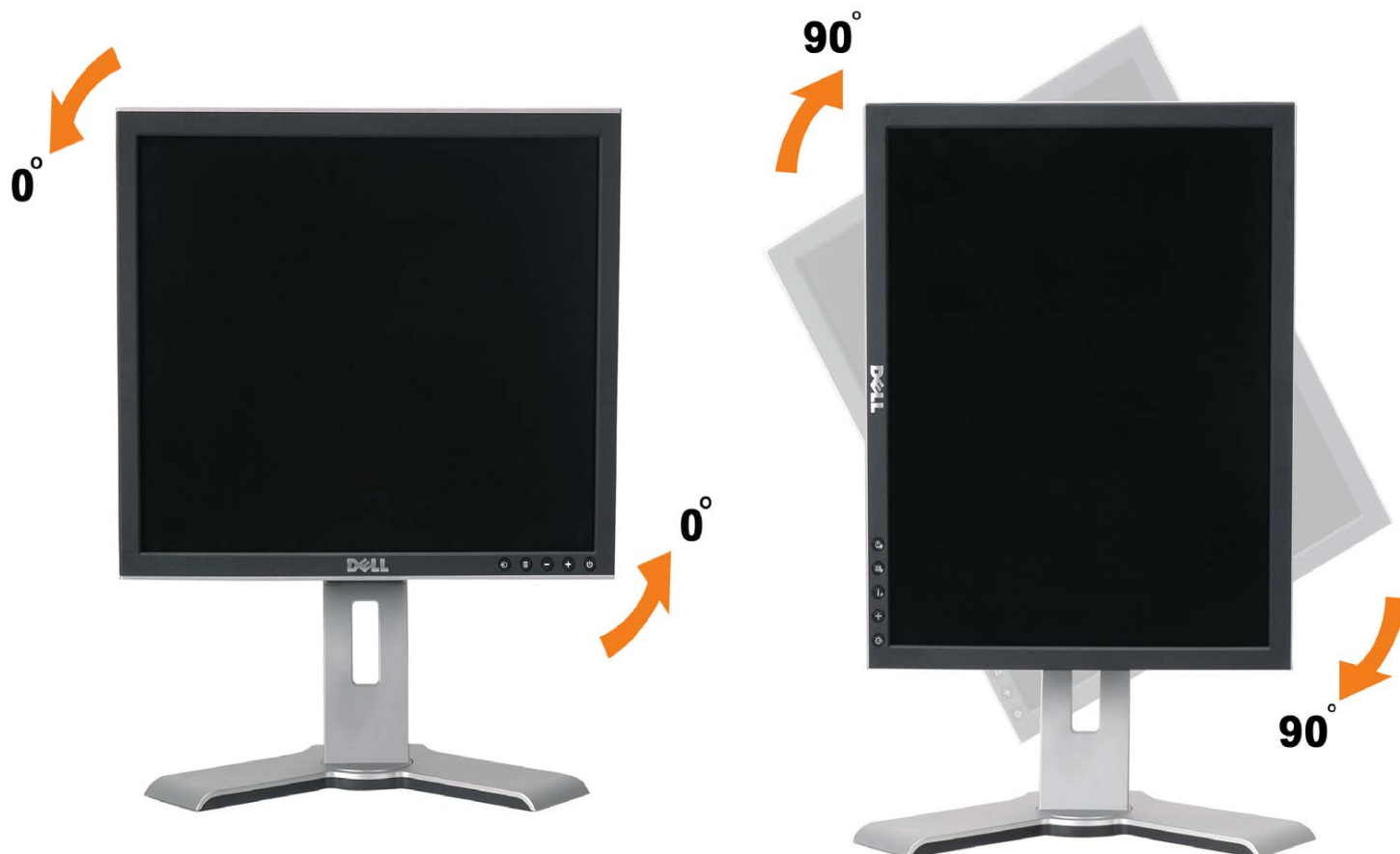

Rotating Your Operating System

After you have rotated your monitor, you need to complete the procedure below to rotate your operating system.

NOTE: If you are using the monitor with a non-Dell computer, you need to go the graphics driver website or your computer manufacturer website for information on rotating your operating system.

1. Right-click on the desktop and click **Properties**.
2. Select the **Settings** tab and click **Advanced**.
3. If you have ATI, select the **Rotation** tab and set the preferred rotation.
If you have nVidia, click the **nVidia** tab, in the left-hand column select **NVRotate**, and then select the preferred rotation.
If you have Intel, select the **Intel** graphics tab, click **Graphic Properties**, select the **Rotation** tab, and then set the preferred rotation.

NOTE: If you do not see the rotation option or it is not working correctly, go to support.dell.com and download the latest driver for your graphics card.

Solving Problems

Dell™ 1707FP Flat Panel Color Monitor User's Guide

- [Troubleshooting Your Monitor](#)
- [General Problems](#)
- [Product Specific Problems](#)
- [USB Problems](#)
- [Troubleshooting Your Soundbar](#)

 **CAUTION:** Before you begin any of the procedures in this section, follow the [safety instructions](#).

Troubleshooting Your Monitor

Self-Test Feature Check (STFC)

Your monitor provides a self-test feature that allows you to check whether your monitor is functioning properly. If your monitor and computer are properly connected but the monitor screen remains dark, run the monitor self-test by performing the following steps:

1. Turn off both your computer and monitor.
2. Unplug the video cable from the back of the computer. To ensure proper Self-Test operation, remove both Digital (white connector) and the Analog (blue connector) cables from the back of computer.
3. Turn on the monitor.

The floating 'Dell Self-test Feature Check' dialog box should appear on a black background if the monitor cannot sense a video signal. Using the input select button, select the desired input to be tested either Analog Input or Digital Input. Disconnect the video cable from the video card and the Dell Self-test Feature Check dialog box will appear if the display is operating correctly.

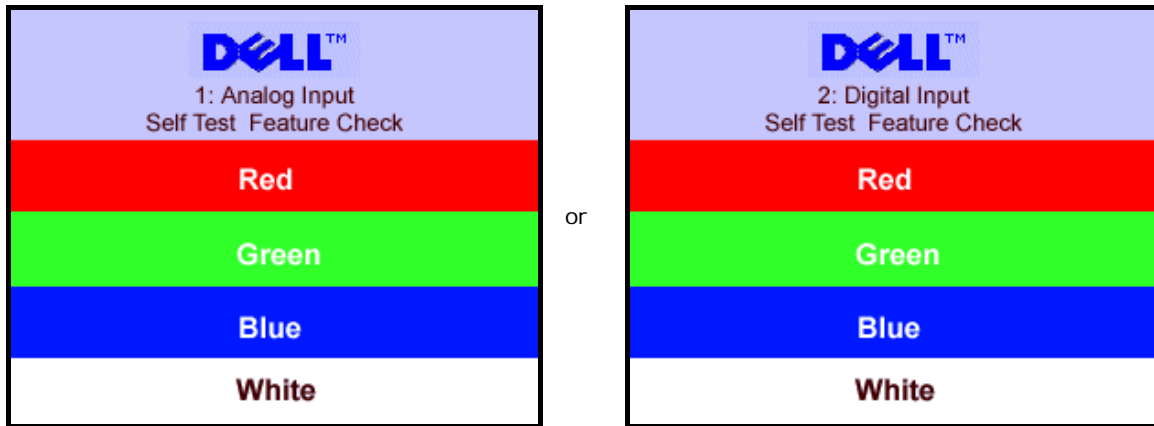

5. This box also appears during normal system operation if the video cable becomes disconnected or damaged.
6. Turn off your monitor and reconnect the video cable, then turn on both your computer and the monitor.

If your monitor screen remains blank after you use the previous procedure, check your video controller and computer system; your monitor is functioning properly.

OSD Warning Messages

One of the following warning messages may appear on the screen indicating that the monitor is out of synchronization.

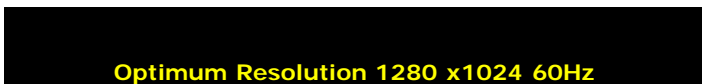

or

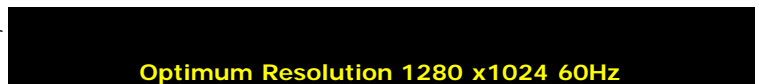

This means that the monitor cannot synchronize with the signal that it is receiving from the computer. Either the signal is too high or too low for the monitor to use. See [Monitor Specifications](#) for the Horizontal and Vertical frequency ranges addressable by this monitor. Recommended mode is 1280 X 1024 @ 60Hz.

Occasionally, no warning message appears, but the screen is blank. This could also indicate that the monitor is not synchronizing with the computer or that the monitor is in a power save mode.

General Problems

The following table contains general information about common monitor problems you might encounter.

COMMON SYMPTOMS	PROBLEM DESCRIPTION	POSSIBLE SOLUTIONS
No Video/Power LED off	No picture, monitor is dead	Check connection integrity at the both ends of the video cable, verify that the monitor and computer are plugged into a working electrical outlet, and that you have pressed the power button.
No Video/Power LED on	No picture or no brightness	<ul style="list-style-type: none"> • Press the input select button in the front of the monitor and ensure the correct input source is selected. • Increase brightness & contrast controls. • Perform monitor self-test feature check. • Check for bent or broken pins on the end of the video cable. • Reboot your computer and monitor.
Poor Focus	Picture is fuzzy, blurry, or ghosting	<ul style="list-style-type: none"> • Push Auto Adjust button. • Adjust Phase and Clock controls via OSD. • Eliminate video extension cables. • Perform monitor reset. • Lower video resolution or increase font size.
Shaky/Jittery Video	Wavy picture or fine movement	<ul style="list-style-type: none"> • Push Auto Adjust button. • Adjust Phase and Clock controls via OSD. • Perform monitor reset. • Check environmental factors. • Relocate and test in another room.
Missing Pixels	LCD screen has spots	<ul style="list-style-type: none"> • Cycle power on-off • These are pixels that are permanently off and this is a natural defect that occurs in LCD technology.
Brightness Problems	Picture too dim or too bright	<ul style="list-style-type: none"> • Perform monitor reset. • Push Auto Adjust button. • Adjust brightness & contrast controls.
Geometric Distortion	Screen not centered correctly	<ul style="list-style-type: none"> • Perform monitor reset on "Position Settings Only". • Push Auto Adjust button. • Adjust the centering controls. • Ensure monitor is in proper video mode.
Horizontal/Vertical Lines	Screen has one or more lines	<ul style="list-style-type: none"> • Perform monitor reset. • Push Auto Adjust button. • Adjust Phase and Clock controls via OSD. • Perform monitor self-test feature check and determine if these lines are also in self-test mode. • Check for bent or broken pins.
Sync Problems	Screen is scrambled or appears torn	<ul style="list-style-type: none"> • Perform monitor reset. • Push Auto Adjust button. • Adjust Phase and Clock controls via OSD. • Perform monitor self-test feature check to determine if scrambled screen appears in self-test mode. • Check for bent or broken pins. • Boot up in the "safe mode".
LCD Scratched	Screen has scratches or smudges	<ul style="list-style-type: none"> • Turn monitor off and clean the screen. • For cleaning instruction, see Caring for your Monitor.
Safety Related Issues	Visible signs of smoke or sparks	<ul style="list-style-type: none"> • Do not perform any troubleshooting steps. • Monitor needs to be replaced.
Intermittent Problems	Monitor malfunctions on and off	<ul style="list-style-type: none"> • Ensure monitor is in proper video mode. • Ensure video cable connection to computer and to the flat panel is secure. • Perform monitor reset.

		<ul style="list-style-type: none"> Perform monitor self-test feature check to determine if the intermittent problem occurs in self-test mode.
Image Retention (from a static image)	Faint Shadow from the static image displayed appears on the screen	<ul style="list-style-type: none"> Use the Power Management feature to turn off the monitor at all times when not in use. Alternatively, use a dynamically changing screensaver left on the monitor for a long period of time.

Product Specific Problems

SPECIFIC SYMPTOMS	WHAT YOU EXPERIENCE	POSSIBLE SOLUTIONS
Screen image is too small	Image is centered on screen, but does not fill entire viewing area.	<ul style="list-style-type: none"> Perform monitor reset on "All Settings."
Cannot adjust the monitor with the buttons on the front panel	OSD does not appear on the screen.	<ul style="list-style-type: none"> Turn off the monitor, unplug the power cord and then plug back and turn on the monitor.

USB Problems

SPECIFIC SYMPTOMS	WHAT YOU EXPERIENCE	POSSIBLE SOLUTIONS
USB interface is not working	USB peripherals are not working.	<ul style="list-style-type: none"> Check that your monitor is turned ON. Reconnect the upstream cable to your computer. Reconnect the USB peripherals (downstream connector). Switch off and then turn on the monitor again.
High Speed USB 2.0 interface is slow	High Speed USB 2.0 peripherals working slowly or not at all.	<ul style="list-style-type: none"> Check that your computer is USB 2.0 capable. Verify USB 2.0 source on your computer. Reconnect the upstream cable to your computer. Reconnect the USB peripherals (downstream connector).

Troubleshooting Your Soundbar

COMMON SYMPTOMS	WHAT YOU EXPERIENCE	POSSIBLE SOLUTIONS
No Sound	No power to Soundbar - the power indicator is off. (built-in DC power supply. i.e. 1905FP)	<ul style="list-style-type: none"> Turn the Power/Volume knob on the Soundbar clockwise to the middle position; check if the power indicator (green LED) on the front of the Soundbar is illuminated. Confirm that the power cable from the Soundbar is plugged into the monitor. Confirm that the monitor has power. If the monitor has no power, see Troubleshooting your monitor for monitor common problem.
No Sound	Soundbar has power - power indicator is on.	<ul style="list-style-type: none"> Plug the audio line-in cable into the computer's audio out jack. Set all Windows volume controls to their maximum. Play some audio content on the computer (i.e. audio CD, or MP3). Turn the Power/Volume knob on the Soundbar clockwise to a higher volume setting. Clean and reseal the audio line-in plug. Test the Soundbar using another audio source (i.e. portable CD player).
Distorted Sound	Computer's sound card is used as the audio source.	<ul style="list-style-type: none"> Clear any obstructions between the Soundbar and the user. Confirm that the audio line-in plug is completely inserted into the jack of the sound card. Set all Windows volume controls to their midpoints. Decrease the volume of the audio application. Turn the Power/Volume knob on the Soundbar counter-clockwise to a lower volume setting. Clean and reseal the audio line-in plug.

		<p>Troubleshoot the computer's sound card.</p> <ul style="list-style-type: none"> • Test the Soundbar using another audio source (i.e. portable CD player).
Distorted Sound	Other audio source is used.	<ul style="list-style-type: none"> • Clear any obstructions between the Soundbar and the user. • Confirm that the audio line-in plug is completely inserted into the jack of the audio source. • Decrease the volume of the audio source. • Turn the Power/Volume knob on the Soundbar counter-clockwise to a lower volume setting. • Clean and reseal the audio line-in plug.
Unbalanced Sound Output	Sound from only one side of Soundbar	<ul style="list-style-type: none"> • Clear any obstructions between the Soundbar and the user. • Confirm that the audio line-in plug is completely inserted into the jack of the sound card or audio source. • Set all Windows audio balance controls (L-R) to their midpoints. • Clean and reseal the audio line-in plug. • Troubleshoot the computer's sound card. • Test the Soundbar using another audio source (i.e. portable CD player).
Low Volume	Volume is too low.	<ul style="list-style-type: none"> • Clear any obstructions between the Soundbar and the user. • Turn the Power/Volume knob on the Soundbar clockwise to the maximum volume setting. • Set all Windows volume controls to their maximum. • Increase the volume of the audio application. • Test the Soundbar using another audio source (i.e. portable CD player).

[Back to Contents Page](#)

Appendix

Dell™ 1707FP Flat Panel Monitor

- [FCC Identification Information](#)
 - [CAUTION: Safety Instruction](#)
 - [Contacting Dell](#)
 - [Your Monitor Set-up Guide](#)
-

FCC Identification Information

FCC Notice (U.S. Only)

FCC Class B

This equipment generates, uses, and can radiate radio frequency energy and, if not installed and used in accordance with the manufacturer's instruction manual, may cause interference with radio and television reception. This equipment has been tested and found to comply with the limits for a Class B digital device pursuant to Part 15 of the FCC Rules.

This device complies with Part 15 of the FCC Rules. Operation is subject to the following two conditions:

- 1 This device may not cause harmful interference.
- 2 This device must accept any interference received, including interference that may cause undesired operation.

 **NOTICE:** The FCC regulations provide that changes or modifications not expressly approved by Dell Inc. could void your authority to operate this equipment.

These limits are designed to provide reasonable protection against harmful interference in a residential installation. However, there is no guarantee that interference will not occur in a particular installation. If this equipment does cause harmful interference with radio or television reception, which can be determined by turning the equipment off and on, you are encouraged to try to correct the interference by one or more of the following measures:

- Reorient the receiving antenna.
- Relocate the system with respect to the receiver.
- Move the system away from the receiver.
- Plug the system into a different outlet so that the system and the receiver are on different branch circuits.

If necessary, consult a representative of Dell Inc. or an experienced radio/television technician for additional suggestions.

The following information is provided on the device or devices covered in this document in compliance with the FCC regulations:

- Product name: 1707FP
- Model number: 1707FPc
- Company name:

Dell Inc.

Worldwide Regulatory Compliance & Environmental Affairs

One Dell Way

Round Rock, TX 78682 USA 512-338-4400

CAUTION: Safety Instruction



CAUTION: Use of controls, adjustments, or procedures other than those specified in this documentation may result in exposure to shock, electrical hazards, and/or mechanical hazards.

Read and follow these instructions when connecting and using your computer monitor:

- To help avoid damaging your computer, be sure that the voltage selection switch on the power supply for the computer is set to match the alternating current (AC) power available at your location:
 - 115 volts (V)/60 hertz (Hz) in most of North and South America and some Far Eastern countries such as Japan, South Korea (also 220 volts (V)/60 hertz (Hz)), and Taiwan.
 - 230 volts (V)/50 hertz (Hz) in most of Europe, the Middle East, and the Far East.

Always be sure that your monitor is electrically rated to operate with the AC power available in your location.

 **NOTE:** This monitor does not need or have a voltage selection switch for setting the AC voltage input. It will automatically accept any AC input voltage according to the ranges defined in the "Electrical Specifications" section.

- Do not store or use the LCD monitor in locations that are exposed to heat, direct sunlight, or extreme cold.
- Avoid moving the LCD monitor between locations with large temperature differences.
- Do not subject the LCD monitor to severe vibration or high impact conditions. For example, do not place the LCD monitor inside a car trunk.
- Do not store or use the LCD monitor in locations exposed to high humidity or dusty environment.
- Do not allow water or other liquids to spill on or into the LCD monitor.
- Keep flat panel monitor in room temperature conditions. Excessive cold or hot conditions can have an adverse effect on the liquid crystal of the display.
- Never insert anything metallic into the monitor openings. Doing so may create the danger of electric shock.
- To avoid electric shock, never touch the inside of the monitor. Only a qualified technician should open the monitor case.
- Never use your monitor if the power cable has been damaged. Do not allow anything to rest on the power cable. Keep the power cable away from where people could trip over it.
- Be sure to grasp the plug, not the cable, when disconnecting the monitor from an electric socket.
- Openings in the monitor cabinet are provided for ventilation. To prevent overheating, these openings should not be blocked or covered. Avoid using the monitor on a bed, sofa, rug, or other soft surface, as doing so may block the ventilation openings in the bottom of the cabinet. If you place the monitor in a bookcase or an enclosed space, be sure to provide adequate ventilation and air flow.
- Place your monitor in a location with low humidity and minimum dust. Avoid places similar to a damp basement or dusty hallway.
- Do not expose the monitor to rain or use it near water (in kitchens, next to swimming pools, etc.). If the monitor accidentally gets wet, unplug it and contact an authorized dealer immediately. You can clean the monitor with a damp cloth when necessary, being sure to unplug the monitor first.
- Place the monitor on a solid surface and treat it carefully. The screen is made of glass and can be damaged if dropped or hit sharply.
- Locate your monitor near an easily accessible electric outlet.
- If your monitor does not operate normally - in particular, if there are any unusual sounds or smells coming from it - unplug it immediately and contact an authorized dealer or service center.
- Do not attempt to remove the back cover, as you will be exposed to an electrical shock hazard. The back cover should only be removed by qualified service personnel.
- High temperatures can cause problems. Don't use your monitor in direct sunlight, and keep it away from heaters, stoves, fireplaces, and other sources of heat.
- Unplug the monitor when it is going to be left unused for an extended period of time.
- Unplug your monitor from the electric outlet before any service is performed.
- Hg Lamp(s) inside this product contains mercury and must be recycled or disposed of according to local, state or federal laws. For more information, Go Or contact the electronic industries alliance: <http://www.eiae.org> for more information.

Contacting Dell

You can contact Dell through the Internet and by phone:

- For support through the web, go to support.dell.com.
- For worldwide support through the web, use the *Choose A Country/Region* menu near the bottom of the page, or see the web addresses listed in the following table.
- For support by e-mail, see the e-mail addresses listed in the following table.

 **NOTE:** Toll-free numbers are for use within the country for which they are listed.

 **NOTE:** In certain countries, support specific to Dell™ XPS™ computers is available at a separate telephone number listed for participating countries. If you do not see a telephone number listed that is specific for XPS computers, you may contact Dell through the support number listed and your call will be routed appropriately.

- For support by phone, use the phone numbers and codes provided in the following table. If you need assistance in determining which codes to use, contact a local or an international operator.

 **NOTE:** The contact information provided was deemed correct at the time that this document went to print and is subject to change.

Country (City) International Access Code Country Code	Service Type	Area Codes, Local Numbers, and Toll-Free Numbers
---	--------------	--

City Code		Web and E-mail Address
Anguilla	Online Support	www.dell.com/ai
	E-mail Address	la-techsupport@dell.com
	Technical Support, Customer Service, Sales	toll-free: 800-335-0031
Antigua and Barbuda	Online Support	www.dell.com.ag la-techsupport@dell.com
	Technical Support, Customer Service, Sales	1-800-805-5924
Aomen	Technical Support	toll-free: 0800-105
Country Code: 853	Customer Service (Xiamen, China)	34 160 910
	Transaction Sales (Xiamen, China)	29 693 115
Argentina (Buenos Aires)	Online Support	www.dell.com.ar
	E-mail for Desktops and Portables	la-techsupport@dell.com
	E-mail for Servers and EMC ® Storage Products	la_enterprise@dell.com
	Customer Service	toll-free: 0-800-444-0730
	Technical Support - Dell PowerApp™, Dell PowerEdge™, Dell PowerConnect™, and Dell PowerVault™	toll-free: 0-800-222-0154
	Technical Support Services	toll-free: 0-800-444-0724
	Sales	0-810-444-3355
Aruba	Online Support	www.dell.com.aw la-techsupport@dell.com
	Technical Support, Customer Service, Sales	toll-free: 800-1578
Australia (Sydney)	Online Support	support.ap.dell.com support.ap.dell.com/contactus
	Technical Support	
	Technical Support for XPS computers only	toll-free: 1300 790 877
	Home and Home Office	toll-free: 1300-655-533
	Medium and Large Business	toll-free: 1800-633-559
	Small Business, Education, Local Government	toll-free: 1800-060-889
	Customer Service	toll-free: 1300-662-196
Austria (Vienna)	Online Support	support.euro.dell.com tech_support_central_europe@dell.com
	Technical Support for XPS computers only	08 20 24 05 30 81
	Home/Small Business Sales	08 20 24 05 30 00
	Home/Small Business Fax	08 20 24 05 30 49
	Home/Small Business Customer Service	08 20 24 05 30 14
	Home/Small Business Support	08 20 24 05 30 17
	Preferred Accounts/Corporate Customer Service	08 20 24 05 30 16
	Preferred Accounts/Corporate Support	08 20 24 05 30 17
	Switchboard	08 20 24 05 30 00
Bahamas	Online Support	www.dell.com/bs la-techsupport@dell.com
	Technical Support, Customer Service, Sales	toll-free: 1-866-874-3038
	Online Support	www.dell.com/bb

<i>Barbados</i>		la-techsupport@dell.com
	Technical Support, Customer Service, Sales	1-800-534-3142
<i>Belgium (Brussels)</i> International Access Code: 00 Country Code: 32 City Code: 2	Online Support	support.euro.dell.com
	Technical Support for XPS computers only	02 481 92 96
	General Support	02 481 92 88
	General Support Fax	02 481 92 95
	Customer Service	02 713 15 65
	Corporate Sales	02 481 91 00
	Fax	02 481 92 99
	Switchboard	02 481 91 00
<i>Bermuda</i>	Online Support	www.dell.com/bm la-techsupport@dell.com
	Technical Support, Customer Service, Sales	1-877-890-0751
<i>Bolivia</i>	Online Support	www.dell.com/bo la-techsupport@dell.com
	Technical Support, Customer Service, Sales	toll-free: 800-10-0238
<i>Brazil</i> International Access Code: 00 Country Code: 55 City Code: 51	Online Support	www.dell.com/br BR_TechSupport@dell.com
	Customer Service and Tech Support	0800 970 3355
	Technical Support Fax	51 2104 5470
	Customer Service Fax	51 2104 5480
	Sales	0800 970 3390
<i>British Virgin Islands</i>	Technical Support, Customer Service, Sales	toll-free: 1-866-278-6820
<i>Brunei</i> Country Code: 673	Technical Support (Penang, Malaysia)	604 633 4966
	Customer Service (Penang, Malaysia)	604 633 3101 or toll-free: 801 1012
	Transaction Sales (Penang, Malaysia)	604 633 3101 or toll-free: 801 1012
<i>Canada (North York, Ontario)</i> International Access Code: 011	Online Order Status	www.dell.ca/ostatus
	Online Support	support.ca.dell.com
	AutoTech (automated Hardware and Warranty Support)	toll-free: 1-800-247-9362
	Customer Service	
	Home/Home Office	toll-free: 1-800-847-4096
	Small Business	toll-free: 1-800-906-3355
	Medium/Large Business, Government, Education	toll-free: 1-800-387-5757
	Hardware Warranty Phone Support	
	XPS Computers Only	toll-free: 1-866-398-8977
	Computers for Home/Home Office	toll-free: 1-800-847-4096
	Computers for Small/Medium/Large Business, Government	toll-free: 1-800-387-5757
	Printers, Projectors, Televisions, Handheld, Digital Jukebox, and Wireless	1-877-335-5767
	Sales	
	Home and Home Office Sales	toll-free: 1-800-999-3355
	Small Business	toll-free: 1-800-387-5752

	Medium/Large Business, Government	toll-free: 1-800-387-5755
	Spare Parts and Extended Service	1 866 440 3355
<i>Cayman Islands</i>	Online Support	la-techsupport@dell.com
	Technical Support, Customer Service, Sales	1-877-262-5415
<i>Chile (Santiago)</i> Country Code: 56 City Code: 2	Online Support	www.dell.com/cl la-techsupport@dell.com
	Sales and Customer Support	toll-free: 1230-020-3397 or 800-20-1385
<i>China (Xiamen)</i> Country Code: 86 City Code: 592	Online Support	support.dell.com.cn
	Technical Support E-mail	support.dell.com.cn/email
	Customer Service E-mail	customer_cn@dell.com
	Technical Support Fax	592 818 1350
	Technical Support - XPS computers only	toll-free: 800 858 0540
	Technical Support - Dell™ Dimension™ and Dell Inspiron™	toll-free: 800 858 2969
	Technical Support - Dell OptiPlex™, Dell Latitude™, and Dell Precision™	toll-free: 800 858 0950
	Technical Support - Servers and Storage	toll-free: 800 858 0960
	Technical Support - Projectors, PDAs, Switches, Routers, etc.	toll-free: 800 858 2920
	Technical Support - Printers	toll-free: 800 858 2311
	Customer Service	toll-free: 800 858 2060
	Customer Service Fax	592 818 1308
	Home and Small Business	toll-free: 800 858 2222
	Preferred Accounts Division	toll-free: 800 858 2557
	Large Corporate Accounts GCP	toll-free: 800 858 2055
	Large Corporate Accounts Key Accounts	toll-free: 800 858 2628
	Large Corporate Accounts North	toll-free: 800 858 2999
	Large Corporate Accounts North Government and Education	toll-free: 800 858 2955
	Large Corporate Accounts East	toll-free: 800 858 2020
	Large Corporate Accounts East Government and Education	toll-free: 800 858 2669
Large Corporate Accounts Queue Team	toll-free: 800 858 2572	
Large Corporate Accounts South	toll-free: 800 858 2355	
Large Corporate Accounts West	toll-free: 800 858 2811	
Large Corporate Accounts Spare Parts	toll-free: 800 858 2621	
<i>Colombia</i>	Online Support	www.dell.com/co la-techsupport@dell.com
	Technical Support, Customer Service, Sales	01-800-915-4755
<i>Costa Rica</i>	Online Support	www.dell.com/cr la-techsupport@dell.com
	Technical Support, Customer Service, Sales	0800-012-0231
<i>Czech Republic (Prague)</i> International Access Code: 00 Country Code: 420	Online Support	support.euro.dell.com czech_dell@dell.com
	Technical Support	22537 2727
	Customer Service	22537 2707
	Fax	22537 2714

	Technical Fax	22537 2728
	Switchboard	22537 2711
Denmark (Copenhagen) International Access Code: 00 Country Code: 45	Online Support	support.euro.dell.com
	Technical Support for XPS computers only	7010 0074
	Technical Support	7023 0182
	Customer Service - Relational	7023 0184
	Home/Small Business Customer Service	3287 5505
	Switchboard - Relational	3287 1200
	Switchboard Fax - Relational	3287 1201
	Switchboard - Home/Small Business	3287 5000
	Switchboard Fax - Home/Small Business	3287 5001
	Dominica	Online Support
Technical Support, Customer Service, Sales		toll-free: 1-866-278-6821
Dominican Republic	Online Support	www.dell.com/do la-techsupport@dell.com
	Technical Support, Customer Service, Sales	1-800-156-1588
Ecuador	Online Support	www.dell.com/ec la-techsupport@dell.com
	Technical Support, Customer Service, Sales (calling from Quito)	toll-free: 999-119-877-655-3355
	Technical Support, Customer Service, Sales (calling from Guayaquil)	toll-free: 1800-999-119-877-655-3355
El Salvador	Online Support	www.dell.com/sv la-techsupport@dell.com
	Technical Support, Customer Service, Sales	800-6132
Finland (Helsinki) International Access Code: 990 Country Code: 358 City Code: 9	Online Support	support.euro.dell.com fi_support@dell.com
	Technical Support	0207 533 555
	Customer Service	0207 533 538
	Switchboard	0207 533 533
	Fax	0207 533 530
	Sales under 500 employees	0207 533 540
	Sales over 500 employees	0207 533 533
France (Paris) (Montpellier) International Access Code: 00 Country Code: 33 City Codes: (1) (4)	Online Support	support.euro.dell.com
	Technical Support for XPS computers only	0825 387 129
	Home and Small Business	
	Technical Support	0825 387 270
	Customer Service	0825 823 833
	Switchboard	0825 004 700
	Switchboard (calls from outside of France)	04 99 75 40 00
	Sales	0825 004 700
	Fax	0825 004 701
	Fax (calls from outside of France)	04 99 75 40 01
	Corporate	

	Technical Support	0825 004 719
	Customer Service	0825 338 339
	Switchboard	01 55 94 71 00
	Sales	01 55 94 71 00
	Fax	01 55 94 71 01
Germany (Frankfurt) International Access Code: 00 Country Code: 49 City Code: 69	Online Support	support.euro.dell.com tech_support_central_europe@dell.com
	Technical Support for XPS computers only	069 9792 7222
	Technical Support	069 9792-7200
	Home/Small Business Customer Service	0180-5-224400
	Global Segment Customer Service	069 9792-7320
	Preferred Accounts Customer Service	069 9792-7320
	Large Accounts Customer Service	069 9792-7320
	Public Accounts Customer Service	069 9792-7320
	Switchboard	069 9792-7000
Greece International Access Code: 00 Country Code: 30	Online Support	support.euro.dell.com
	Technical Support	00800-44 14 95 18
	Gold Service Technical Support	00800-44 14 00 83
	Switchboard	2108129810
	Gold Service Switchboard	2108129811
	Sales	2108129800
	Fax	2108129812
Grenada	Online Support	www.dell.com/gd la-techsupport@dell.com
	Technical Support, Customer Service, Sales	toll-free: 1-866-540-3355
Guatemala	Online Support	www.dell.com/gt la-techsupport@dell.com
	Technical Support, Customer Service, Sales	1-800-999-0136
Guyana	Online Support	la-techsupport@dell.com
	Technical Support, Customer Service, Sales	toll-free: 1-877-270-4609
Hong Kong International Access Code: 001 Country Code: 852	Online Support	support.ap.dell.com support.dell.com.cn/email
	Technical Support - XPS computers only	00852-3416 6923
	Technical Support - Dimension and Inspiron	00852-2969 3188
	Technical Support - OptiPlex, Latitude, and Dell Precision	00852-2969 3191
	Technical Support - Servers and Storage	00852-2969 3196
	Technical Support - Projectors, PDAs, Switches, Routers, etc.	00852-3416 0906
	Customer Service	00852-3416 0910
	Large Corporate Accounts	00852-3416 0907
	Global Customer Programs	00852-3416 0908
	Medium Business Division	00852-3416 0912
	Home and Small Business Division	00852-2969 3105
	Online Support	support.ap.dell.com
	Portable and Desktop Support	

India

Desktop Support E-mail	india_support_desktop@dell.com
Portable Support E-mail	india_support_notebook@dell.com
Phone Numbers	080-25068032 or 080-25068034 or your city STD code + 60003355 or toll-free: 1-800-425-8045
<i>Server Support</i>	
E-mail	india_support_Server@dell.com
Phone Numbers	080-25068032 or 080-25068034 or your city STD code + 60003355 or toll-free: 1800 425 8045
<i>Gold Support Only</i>	
E-mail	eec_ap@dell.com
Phone Numbers	080-25068033 or your city STD code + 60003355 or toll-free: 1-800-425-9045
<i>XPS Support Only</i>	
E-mail	Indiaxps_AP@dell.com
Phone Numbers	080-25068066 or toll-free: 1-800-425-2066
Customer Service	
Home and Small Business	India_care_HSB@dell.com toll-free: 1800-4254051
Large Corporate Accounts	India_care_REL@dell.com toll-free: 1800-4252067
<i>Sales</i>	
Large Corporate Accounts	1600 33 8044
Home and Small Business	1600 33 8046

Ireland (Cherrywood)

International Access Code: 00

Country Code: 353

City Code: 1

Online Support	support.euro.dell.com dell_direct_support@dell.com
<i>Technical Support</i>	
XPS computers only	1850 200 722
<i>Business computers</i>	1850 543 543
Home computers	1850 543 543
At Home Support	1850 200 889
<i>Sales</i>	
Home	1850 333 200
Small Business	1850 664 656
Medium Business	1850 200 646
Large Business	1850 200 646
Sales E-mail	Dell_IRL_Outlet@dell.com
<i>Customer Service</i>	
Home and Small Business	01 204 4014
Business (greater than 200 employees)	1850 200 982
<i>General</i>	
Fax/Sales Fax	01 204 0103
Switchboard	01 204 4444

	U.K. Customer Service (dial within U.K. only)	0870 906 0010
	Corporate Customer Service (dial within U.K. only)	0870 907 4499
	U.K. Sales (dial within U.K. only)	0870 907 4000
Italy (Milan) International Access Code: 00 Country Code: 39 City Code: 02	Online Support	support.euro.dell.com
	Home and Small Business	
	Technical Support	02 577 826 90
	Customer Service	02 696 821 14
	Fax	02 696 821 13
	Switchboard	02 696 821 12
	Corporate	
	Technical Support	02 577 826 90
	Customer Service	02 577 825 55
	Fax	02 575 035 30
	Switchboard	02 577 821
Jamaica	Online Support	ja-techsupport@dell.com
	Technical Support, Customer Service, Sales (dial from within Jamaica only)	1-800-440-9205
Japan (Kawasaki) International Access Code: 001 Country Code: 81 City Code: 44	Online Support	support.jp.dell.com
	Technical Support - XPS computers only	toll-free: 0120-937-786
	Technical Support outside of Japan - XPS computers only	81-44-520-1235
	Technical Support - Dimension and Inspiron	toll-free: 0120-198-226
	Technical Support outside of Japan - Dimension and Inspiron	81-44-520-1435
	Technical Support - Dell Precision, OptiPlex, and Latitude	toll-free: 0120-198-433
	Technical Support outside of Japan - Dell Precision, OptiPlex, and Latitude	81-44-556-3894
	Technical Support - Dell PowerApp, Dell PowerEdge, Dell PowerConnect, and Dell PowerVault	toll-free: 0120-198-498
	Technical Support outside of Japan - PowerApp, PowerEdge, PowerConnect, and PowerVault	81-44-556-4162
	Technical Support - Projectors, PDAs, Printers, Routers	toll-free: 0120-981-690
	Technical Support outside of Japan - Projectors, PDAs, Printers, Routers	81-44-556-3468
	Faxbox Service	044-556-3490
	24-Hour Automated Order Status Service	044-556-3801
	Customer Service	044-556-4240
	Business Sales Division - up to 400 employees	044-556-1465
	Preferred Accounts Division Sales - over 400 employees	044-556-3433
	Public Sales - government agencies, educational institutions, and medical institutions	044-556-5963
	Global Segment Japan	044-556-3469
	Individual User	044-556-1657
	Individual User Online Sales	044-556-2203
Individual User Real Site Sales	044-556-4649	
	Switchboard	044-556-4300
Korea (Seoul) International Access Code: 001 Country Code: 82 City Code: 2	Online Support	support.ap.dell.com
	Technical Support for XPS computers only	toll-free: 080-999-0283
	Technical Support, Customer Service	toll-free: 080-200-3800
	Technical Support - Dimension, PDA, Electronics, and Accessories	toll-free: 080-200-3801
	Sales	toll-free: 080-200-3600
	Fax	2194-6202
	Switchboard	2194-6000

<i>Latin America</i>	Customer Technical Support (Austin, Texas, U.S.A.)	512 728-4093
	Customer Service (Austin, Texas, U.S.A.)	512 728-3619
	Fax (Technical Support and Customer Service) (Austin, Texas, U.S.A.)	512 728-3883
	Sales (Austin, Texas, U.S.A.)	512 728-4397
	Sales Fax (Austin, Texas, U.S.A.)	512 728-4600 or 512 728-3772
<i>Luxembourg</i> International Access Code: 00 Country Code: 352	Online Support	support.euro.dell.com
	Support	342 08 08 075
	Home/Small Business Sales	+32 (0)2 713 15 96
	Corporate Sales	26 25 77 81
	Customer Service	+32 (0)2 481 91 19
	Fax	26 25 77 82
<i>Malaysia (Penang)</i> International Access Code: 00 Country Code: 60 City Code: 4	Online Support	support.ap.dell.com
	Technical Support - XPS computers only	toll-free: 1 800 885 784
	Technical Support - Dell Precision, OptiPlex, and Latitude	toll-free: 1 800 880 193
	Technical Support - Dimension, Inspiron, and Electronics and Accessories	toll-free: 1 800 881 306
	Technical Support - PowerApp, PowerEdge, PowerConnect, and PowerVault	toll-free: 1800 881 386
	Customer Service	toll-free: 1800 881 306 (option 6)
	Transaction Sales	toll-free: 1 800 888 202
	Corporate Sales	toll-free: 1 800 888 213
<i>Mexico</i> International Access Code: 00 Country Code: 52	Online Support	www.dell.com/mx la-techsupport@dell.com
	Technical Support	001-866-563-4425
	Sales	50-81-8800 or 001-800-888-3355
	Customer Service	001-877-384-8979 or 001-877-269-3383
	Main	50-81-8800 or 001-800-888-3355 or 001-866-851-1754
<i>Montserrat</i>	Online Support	la-techsupport@dell.com
	Technical Support, Customer Service, Sales	toll-free: 1-866-278-6822
<i>Netherlands Antilles</i>	Online Support	la-techsupport@dell.com
	Technical Support, Customer Service, Sales	001-800-882-1519
<i>Netherlands (Amsterdam)</i> International Access Code: 00 Country Code: 31 City Code: 20	Online Support	support.euro.dell.com
	Technical Support for XPS computers only	020 674 45 94
	Technical Support	020 674 45 00
	Technical Support Fax	020 674 47 66
	Home/Small Business Customer Service	020 674 42 00
	Relational Customer Service	020 674 4325
	Home/Small Business Sales	020 674 55 00
	Relational Sales	020 674 50 00
	Home/Small Business Sales Fax	020 674 47 75

	Relational Sales Fax	020 674 47 50
	Switchboard	020 674 50 00
	Switchboard Fax	020 674 47 50
<i>New Zealand</i> International Access Code: 00 Country Code: 64	Online Support	support.ap.dell.com support.ap.dell.com/contactus
	Technical Support for XPS computers only	toll-free: 0800 335 540
	Technical Support, Customer Service, Sales	0800 441 567
<i>Nicaragua</i>	Online Support	www.dell.com/ni la-techsupport@dell.com
	Technical Support, Customer Service, Sales	001-800-220-1377
<i>Norway (Lysaker)</i> International Access Code: 00 Country Code: 47	Online Support	support.euro.dell.com
	Technical Support for XPS computers only	815 35 043
	Technical Support	671 16882
	Relational Customer Service	671 17575
	Home/Small Business Customer Service	23162298
	Switchboard	671 16800
	Fax Switchboard	671 16865
<i>Panama</i>	Online Support	www.dell.com/pa la-techsupport@dell.com
	Technical Support, Customer Service, Sales	011-800-507-1264
<i>Peru</i>	Online Support	www.dell.com/pe la-techsupport@dell.com
	Technical Support, Customer Service, Sales	0800-50-669
<i>Poland (Warsaw)</i> International Access Code: 011 Country Code: 48 City Code: 22	Online Support	support.euro.dell.com pl_support_tech@dell.com
	Customer Service Phone	57 95 700
	Customer Service	57 95 999
	Sales	57 95 999
	Customer Service Fax	57 95 806
	Reception Desk Fax	57 95 998
	Switchboard	57 95 999
<i>Portugal</i> International Access Code: 00 Country Code: 351	Online Support	support.euro.dell.com
	Technical Support	707200149
	Customer Service	800 300 413
	Sales	800 300 410 or 800 300 411 or 800 300 412 or 21 422 07 10
	Fax	21 424 01 12
<i>Puerto Rico</i>	Online Support	www.dell.com/pr la-techsupport@dell.com
	Technical Support	toll-free: 1-866-390-4695 or 1-866-851-1760
	Customer Service and Sales	1-877-537-3355
		www.dell.com/kn

<i>St. Kitts and Nevis</i>	Online Support	la-techsupport@dell.com
	Technical Support, Customer Service, Sales	toll-free: 1-866-540-3355
<i>St. Lucia</i>	Online Support	www.dell.com/lc la-techsupport@dell.com
	Technical Support, Customer Service, Sales	toll-free: 1-866-464-4352
<i>St. Vincent and the Grenadines</i>	Online Support	www.dell.com/vc la-techsupport@dell.com
	Technical Support, Customer Service, Sales	toll-free: 1-866-464-4353
<i>Singapore (Singapore)</i> International Access Code: 005 Country Code: 65	<ul style="list-style-type: none"> The phone numbers in this section should be called from within Singapore or Malaysia only. 	
	Online Support	support.ap.dell.com
	Technical Support - XPS computers only	toll-free: 1800 394 7464
	Technical Support - Dimension, Inspiron, and Electronics and Accessories	toll-free: 1 800 394 7430
	Technical Support - OptiPlex, Latitude, and Dell Precision	toll-free: 1 800 394 7488
	Technical Support - PowerApp, PowerEdge, PowerConnect, and PowerVault	toll-free: 1 800 394 7478
	Customer Service	toll-free: 1 800 394 7430 (option 6)
	Transaction Sales	toll-free: 1 800 394 7412
Corporate Sales	toll-free: 1 800 394 7419	
<i>Slovakia (Prague)</i> International Access Code: 00 Country Code: 421	Online Support	support.euro.dell.com czech_dell@dell.com
	Technical Support	02 5441 5727
	Customer Service	420 22537 2707
	Fax	02 5441 8328
	Tech Fax	02 5441 8328
	Switchboard (Sales)	02 5441 7585
<i>South Africa (Johannesburg)</i> International Access Code: 09/091 Country Code: 27 City Code: 11	Online Support	support.euro.dell.com dell_za_support@dell.com
	Gold Queue	011 709 7713
	Technical Support	011 709 7710
	Customer Service	011 709 7707
	Sales	011 709 7700
	Fax	011 706 0495
	Switchboard	011 709 7700
<i>Southeast Asian and Pacific Countries</i>	Technical Support, Customer Service, and Sales (Penang, Malaysia)	604 633 4810
<i>Spain (Madrid)</i> International Access Code: 00 Country Code: 34 City Code: 91	Online Support	support.euro.dell.com
	<i>Home and Small Business</i>	
	Technical Support	902 100 130
	Customer Service	902 118 540
	Sales	902 118 541
	Switchboard	902 118 541
	Fax	902 118 539
	<i>Corporate</i>	
Technical Support	902 100 130	

	Customer Service	902 115 236
	Switchboard	91 722 92 00
	Fax	91 722 95 83
Sweden (Upplands Vasby) International Access Code: 00 Country Code: 46 City Code: 8	Online Support	support.euro.dell.com
	Technical Support for XPS computers only	77 134 03 40
	Technical Support	08 590 05 199
	Relational Customer Service	08 590 05 642
	Home/Small Business Customer Service	08 587 70 527
	Employee Purchase Program (EPP) Support	020 140 14 44
	Technical Support Fax	08 590 05 594
	Sales	08 587 705 81
Switzerland (Geneva) International Access Code: 00 Country Code: 41 City Code: 22	Online Support	support.euro.dell.com Tech_support_central_Europe@dell.com
	Technical Support for XPS computers only	0848 338 857
	Technical Support - Home and Small Business	0844 811 411
	Technical Support - Corporate	0844 822 844
	Customer Service - Home and Small Business	0848 802 202
	Customer Service - Corporate	0848 821 721
	Main	0848 335 599
	Fax	022 799 01 90
	Sales	022 799 01 01
Taiwan International Access Code: 002 Country Code: 886	Online Support	support.ap.dell.com support.dell.com.cn/email
	Technical Support - XPS computers only	toll-free: 0080 186 3085
	Technical Support - OptiPlex, Latitude, Inspiron, Dimension, and Electronics and Accessories	toll-free: 0080 186 1011
	Technical Support - Servers and Storage	toll-free: 0080 160 1256
	Customer Service	toll-free: 0080 160 1250 (option 5)
	Transaction Sales	toll-free: 0080 165 1228
	Corporate Sales	toll-free: 0080 165 1227
Thailand International Access Code: 001 Country Code: 66	Online Support	support.ap.dell.com
	Technical Support (OptiPlex, Latitude, and Dell Precision)	toll-free: 1800 0060 07
	Technical Support (PowerApp, PowerEdge, PowerConnect, and PowerVault)	toll-free: 1800 0600 09
	Customer Service	toll-free: 1800 006 007 (option 7)
	Corporate Sales	toll-free: 1800 006 009
	Transaction Sales	toll-free: 1800 006 006
Trinidad/Tobago	Online Support	www.dell.com/tt la-techsupport@dell.com
	Technical Support, Customer Service, Sales	toll-free: 1-888-799-5908
Turks and Caicos Islands	Online Support	www.dell.com/tc la-techsupport@dell.com
	Technical Support, Customer Service, Sales	toll-free: 1-877-441-4735
		support.euro.dell.com

U.K. (Bracknell)

International Access Code: 00

Country Code: 44

City Code: 1344

Online Support	dell_direct_support@dell.com
Customer Service Online support.euro.dell.com/uk/en/ECare/form/home.asp	
<i>Sales</i>	
Home and Small Business Sales	0870 907 4000
Corporate/Public Sector Sales	01344 860 456
<i>Customer Service</i>	
Home and Small Business	0870 906 0010
Corporate	01344 373 185
Preferred Accounts (500-5000 employees)	0870 906 0010
Global Accounts	01344 373 186
Central Government	01344 373 193
Local Government & Education	01344 373 199
Health	01344 373 194
<i>Technical Support</i>	
XPS Computers Only	0870 366 4180
Corporate/Preferred Accounts/PCA (1000+ employees)	0870 908 0500
Other Dell Products	0870 353 0800
<i>General</i>	
Home and Small Business Fax	0870 907 4006

Uruguay

Online Support	www.dell.com/uy la-techsupport@dell.com
Technical Support, Customer Service, Sales	toll-free: 000-413-598-2521

U.S.A. (Austin, Texas)

International Access Code: 011

Country Code: 1

Dell Services for the Deaf, Hard-of-Hearing, or Speech-Impaired	toll-free: 1-877-DELLTTY (1-877-335-5889)
Fax	toll-free: 1-800-727-8320
Technical Support	support.dell.com
XPS	toll-free: 1-800-232-8544
Home and Home Office	toll-free: 1-800-624-9896
Portable and Desktop AutoTech	toll-free: 1-800-247-9362
Small Business	toll-free: 1-800-456-3355
Medium and Large Business	toll-free: 1-877-671-3355
State and Local Government	toll-free: 1-800-981-3355
Federal Government	toll-free: 1-800-727-1100
Healthcare	toll-free: 1-800-274-1550
K-12 Education	toll-free: 1-888-977-3355
Higher Education	toll-free: 1-800-274-7799
Printers, Projectors, PDAs, and MP3 Players	toll-free: 1-877-459-7298
Customer Service	toll-free: 1-800-624-9897
Automated Order Status	toll-free: 1-800-433-9014
Small Business	toll-free: 1-800-456-3355
Medium and Large Business	toll-free: 1-877-671-3355
State and Local Government	toll-free: 1-800-981-3355
Federal Government	toll-free: 1-800-727-1100
Healthcare	toll-free: 1-800-274-1550

	K-12 Education	toll-free: 1-888-977-3355
	Higher Education	toll-free: 1-800-274-7799
	Employee Purchase Program (EPP)	toll-free: 1-800-695-8133
	<i>Financial Services</i>	<i>www.dellfinancialservices.com</i>
	Leases and Loans	toll-free: 1-877-577-3355
	Dell Preferred Accounts (DPA)	toll-free: 1-800-283-2210
	<i>Sales</i>	1-800-289-3355 or 1-800-879-3355
	Dell Outlet Store	toll-free: 1-888-798-7561
	Software and Peripherals Sales	toll-free: 1-800-671-3355
U.S. Virgin Islands	Online Support	www.dell.com/vi la-techsupport@dell.com
	Technical Support, Customer Service, Sales	toll-free: 1-877-702-4360
Venezuela	Online Support	www.dell.com/ve la-techsupport@dell.com
	Technical Support, Customer Service, Sales	0800-100-4752

Your Monitor Set-up Guide

To view PDF files (files with an extension of **.pdf**), click the document title. To save PDF files (files with an extension of **.pdf**) to your hard drive, right-click the document title, click **Save Target As** in Microsoft® Internet Explorer or **Save Link As** in Netscape Navigator, and then specify a location on your hard drive to which you want to save the files.

[Setup Guide \(.pdf\)](#)

 **NOTES:** PDF files require Adobe® Acrobat® Reader®, which can be downloaded from the Adobe website at www.adobe.com. To view a PDF file, launch Acrobat Reader. Then click **File® Open** and select the PDF file.

[Back to Contents Page](#)



Setting Up Your Monitor

Paramétrer votre moniteur | Instalación del monitor | Instalar o monitor |
Inbetriebnahme des Monitors | Configurazione del monitor | Instalacja monitora



CAUTION:

Before you set up and operate your Dell monitor, see the safety instructions in your monitor "Product Information Guide." See your User's Guide for a complete list of features.

MISE EN GARDE :

Avant d'installer et d'utiliser votre écran Dell, veuillez vous référer aux consignes de sécurité données dans le "Guide des Informations du Produit" de votre moniteur. Consultez également votre Guide Utilisateur pour obtenir la liste complète des fonctions.

PRECAUCIÓN:

Antes de configurar y utilizar el monitor Dell, consulte las instrucciones de seguridad contenidas en la "Guía de información del producto" que acompaña al monitor. Consulte también la Guía del usuario para obtener una lista completa de las funciones.

ATENÇÃO:

Antes de instalar e utilizar o seu monitor Dell, consulte as normas de segurança no "Guia de informação do produto" do seu monitor. Consulte também o Guia do utilizador para obter a lista completa de funções.

ACHTUNG:

Bevor Sie Ihren Dell-Monitor einrichten und in Betrieb setzen, lesen Sie die "Sicherheitshinweise in der Produktanleitung" Ihres Monitors. Lesen Sie auch die umfassende Liste mit Funktionen in Ihrer Bedienungsanleitung.

ATTENZIONE:

Prima di installare e utilizzare il monitor Dell, leggere le norme di sicurezza sull'uso del monitor "Guida informativa al prodotto". Si veda anche la Guida utente per avere l'elenco completo delle funzioni.

OSTRZEŻENIE:

Przed wykonaniem ustawień i rozpoczęciem używania monitora Dell należy przeczytać instrukcje bezpieczeństwa w "Podręczniku informacji o produkcie" monitora. Informacje dotyczące pełnej listy funkcji znajdują się w Podręczniku użytkownika.

Dell™ 1707FP Flat Panel Monitor

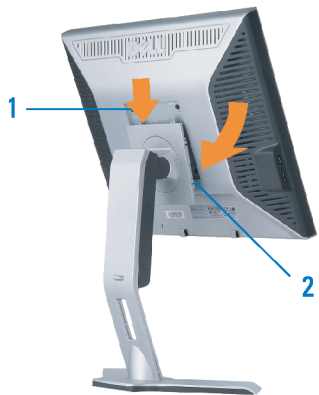

1

Attach the monitor to the stand.

Fixez le moniteur sur le socle.
Acople el monitor a la base.
Coloque o monitor no suporte.
Den Monitor auf den Fuß befestigen.
Fissare il monitor alla base.
Podłącz monitor do podstawy.

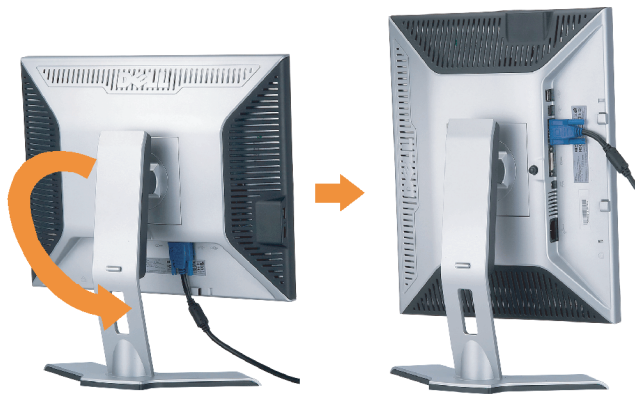

2

Rotate the monitor to connect the cables.

Pivotez le moniteur pour connecter les câbles.
Gire el monitor para conectar los cables.
Rode o monitor para ligar os cabos.
Drehen Sie den Monitor um die eigene Achse, um die Kabel anzuschließen.
Ruotare il monitor per collegare i cavi.
Obróć monitor w celu podłączenia kabli.

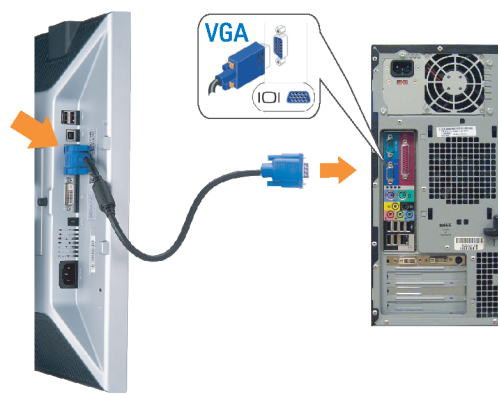

3

Connect the blue VGA cable to the computer.

Connectez le câble VGA bleu à votre ordinateur.
Conecte el cable VGA azul al equipo.
Ligue o cabo VGA ao computador.
Schließen Sie das blaue VGA-Kabel an den Computer an.
Collegare il cavo VGA di color blu al computer.
Podłącz niebieski kabel VGA do komputera.

OR

ou
o
ou
oder
e
lub

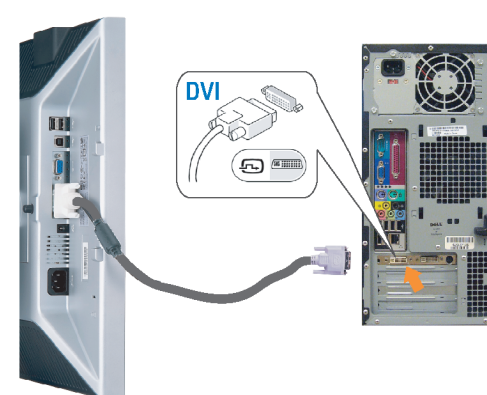

Connect the optional white DVI cable to the computer.

Connectez le câble DVI blanc optionnel à votre ordinateur.
Conecte el cable DVI blanco opcional al equipo.
Ligue o cabo DVI branco opcional ao computador.
Schließen Sie das optionale, weiße DVI-Kabel an den Computer an.
Collegare il cavo DVI opzionale, di colore bianco, al computer.
Podłącz opcjonalny, biały kabel DVI do komputera.

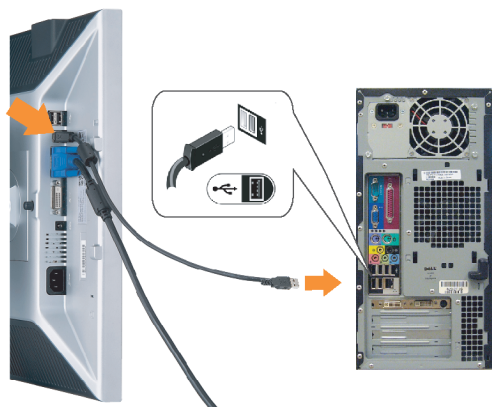

4

Connect the USB cable to the computer.

Connectez le câble USB sur l'ordinateur.
Conecte el cable USB a su computador.
Ligue o cabo USB ao computador.
Verbinden Sie das USB-Kabel mit dem Computer.
Collegare il cavo USB al computer.
Podłącz kabel USB do komputera.

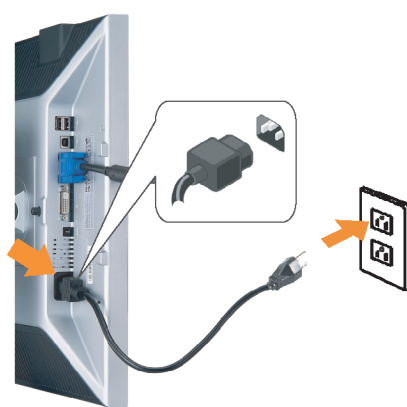

5

Connect the power cord firmly to the monitor and the electrical outlet.

Connectez fermement le cordon d'alimentation au moniteur et à une prise murale.
Conecte el cable de alimentación firmemente al monitor y a la toma de corriente.
Ligue o cabo de alimentação ao monitor e à tomada elétrica.
Schließen Sie die Netzleitung ordnungsgemäß an den Monitor und eine Steckdose an.
Collegare bene il cavo di alimentazione al monitor e alla presa elettrica.
Podłącz pewnie przewód zasilający do monitora i gniazdka elektrycznego.



6

Rotate the monitor back and turn on the monitor.

Pivotez de nouveau le moniteur pour retrouver sa position initiale et allumez-le.
Vuelva a girar el monitor y enciéndalo.
Rode o monitor para a posição original e ligue-o.
Drehen Sie den Monitor wieder in die Ausgangsposition und schalten Sie ihn ein.
Ruotare il monitor per riportarlo nella posizione originale e accenderlo.
Obróć monitor do poprzedniej pozycji i włącz monitor.

7

If nothing appears on the screen, press the Input Select button.

Si aucune image n'apparaît sur l'écran, appuyez sur le bouton Sélection d'Entrée.
Si no aparece nada en la pantalla, pulse el botón Selección de entrada.
Se não aparecer nada no ecrã, prima o botão selecção de entrada.
Wenn nichts auf dem Bildschirm erscheint, drücken Sie bitte die Eingangsauswahl-Taste.
Se sullo schermo non appare nulla, premere il tasto Seleziona ingresso.
Jeśli nic nie wyświetli się na ekran naciśnij przycisk Wybór wejścia.



7730203259P0B

www.dell.com | support.dell.com



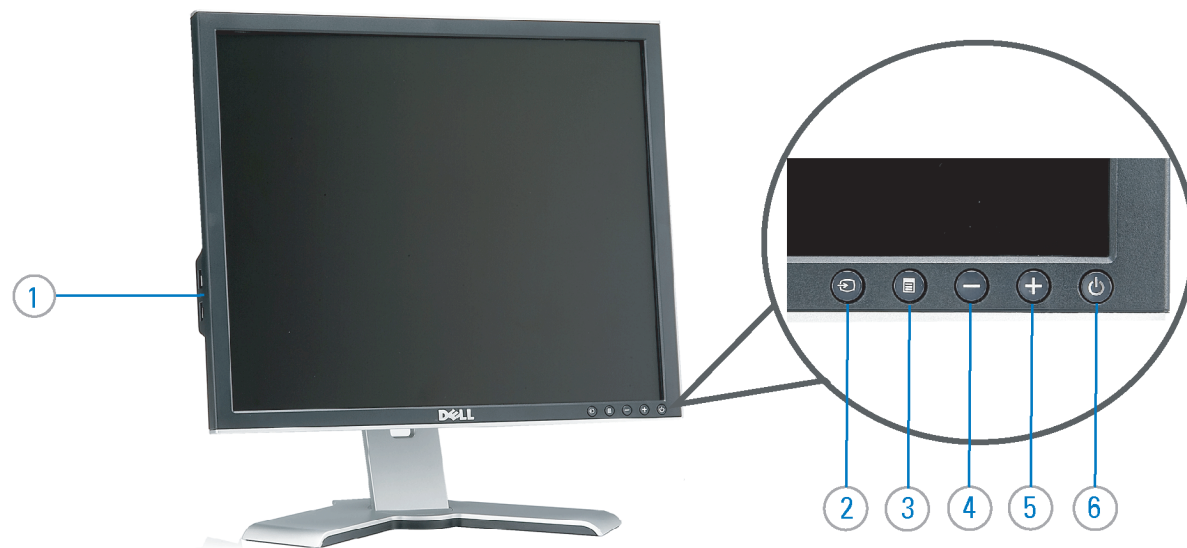

1. USB downstream port
2. Video Input Select
3. OSD Menu/Select
4. Down
5. Up
6. Power button (with power light indicator)
7. Cable management hole
8. Lock down/release button
9. Security lock slot
10. Dell Soundbar mounting brackets
11. Power Out for Dell Soundbar
12. Monitor Lock/Release Button

1. USB-Downstream-Anschluss
2. Videoeingang-Auswahl/Unten
3. OSD Menü/Auswahl
4. Unten
5. Oben
6. Netzschalter (mit Betriebsanzeige)
7. Loch für Kabelverwaltung
8. Taste Einrasten/Ausrasten
9. Diebstahlsicherung
10. Dell Soundbar-Montagehalter
11. Ausschalter für Dell Soundbar
12. Bildschirm Ver-/Entriegelungstaste

1. Port USB flux descendant
2. Sélectionner l'Entrée vidéo
3. Menu OSD/Sélectionner
4. Bas
5. Haut
6. Bouton Alimentation (avec témoin lumineux d'alimentation)
7. Trou de rangement des câbles
8. Bouton verrouillage/libération
9. Orifice de verrouillage de sécurité
10. Support de montage de la Soundbar Dell
11. Sortie alimentation pour Dell Soundbar
12. Moniteur verrouillage/déverrouillage du panneau LCD

1. Porta USB per il downstream
2. Selezione ingresso video
3. Menu OSD/Selezione
4. Giù
5. Su
6. Tasto di accensione (con indicatore luminoso)
7. Foro per il passaggio dei cavi
8. Pulsante blocco/rilascio
9. Slot per blocco di sicurezza
10. Staffe di montaggio Dell Soundbar
11. Uscita alimentazione per Soundbar Dell
12. Tasto blocco/rilascio pannello

1. Puerto de descarga USB
2. Seleccionar entrada de vídeo
3. Menú OSD/Seleccionar
4. Bajar
5. Subir
6. Botón de encendido (con indicador luminoso de encendido)
7. Orificio para la administración de cables
8. Botón para bloque/liberación
9. Ranura de bloqueo de seguridad
10. Soportes de montaje para la barra de sonidos Dell
11. Desconexión para Dell Soundbar
12. Botón para bloquear o liberar el panel LCD

1. Port pobierania danych (downstream) USB
2. Wybór wejścia video
3. Menu OSD/Wybór
4. W dół
5. W górę
6. Przycisk zasilania (ze wskaźnikiem zasilania)
7. Otwór prowadzenia kabli
8. Przycisk blokowania/zwolnienia blokady
9. Gniazdo blokady zabezpieczenia
10. Wsporniki montażowe Dell Soundbar
11. Panela dźwiękowego Dell
12. Przycisk blokady/zwolnienia monitor

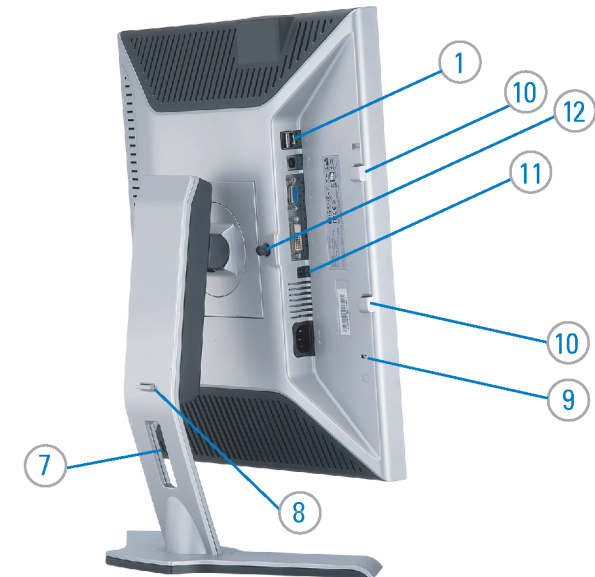

1. Porta USB downstream
2. Seleccionar entrada de video
3. Menu OSD/Seleccionar
4. Para baixo
5. Para cima
6. Botão de alimentação (com LED indicador de alimentação)
7. Orifício para gestão dos cabos
8. Botão de fixação/libertação
9. Ranhura para travamento de segurança
10. Suportes de montagem para o Dell Soundbar
11. Desligar sistema de som Dell
12. Botão de bloqueio/desbloqueio do painel LCD

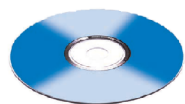

Finding Information

See your monitor User's Guide in the CD, for more information.

Trouver les Informations

Référez-vous au Guide Utilisateur de votre moniteur sur le CD pour les informations complémentaires.

Búsqueda de información

Para obtener más información consulte la Guía del usuario del monitor contenida en el CD.

Procurar informação

Para obter mais informações, consulte o Guia do usuário do seu monitor que vem incluído no CD.

Finden von Informationen

Weitere Informationen sind in der Bedienungsanleitung Ihres Monitors auf der CD angegeben.

Dove reperire informazioni

Consultare la Guida utente nel CD, per avere maggiori informazioni.

Znajdowanie informacji

Dalsze informacje znajdują się w Podręczniku użytkownika monitora na dysku CD.

Information in this document is subject to change without notice.
© 2005 Dell Inc. All rights reserved.

Reproduction in any manner whatsoever without the written permission of Dell Inc. is strictly forbidden.

Dell and the DELL logo are trademarks of Dell Inc. Dell disclaims proprietary interest in the marks and names of others.

November 2005

Les informations contenues dans ce document peuvent être soumises à des modifications sans préavis.
© 2005 Dell Inc. Tous droits réservés.

Toute reproduction, par quelque manière que ce soit, est strictement interdite sans l'autorisation écrite de Dell Inc.

Dell et le logo DELL sont la propriété de Dell Inc. Tous les autres noms commerciaux ou noms de marques sont la propriété de leurs détenteurs respectifs.

Novembre 2005

La información contenida en este documento está sujeta a cambios sin previo aviso.
© 2005 Dell Inc. Reservados todos los derechos.

Se prohíbe estrictamente la reproducción de este documento en cualquier forma sin permiso por escrito de Dell Inc.

Dell y el logotipo DELL son marcas registradas de Dell Inc. Dell renuncia al derecho de posesión sobre las marcas y nombres de terceros.

Noviembre 2005

As informações contidas neste documento estão sujeitas a alterações sem aviso prévio.
© 2005 Dell Inc. Corporation. Todos os direitos reservados.

A reprodução de qualquer forma sem permissão por escrito de Dell Inc. é estritamente proibida.

Dell e o logotipo DELL são marcas comerciais da Dell Inc. A Dell exclui quaisquer interesses de propriedade nas marcas e nomes de outros.

Novembro 2005

Die Informationen in diesem Dokument unterliegen unangekündigten Änderungen.
© 2005 Dell Inc. Alle Rechte vorbehalten.

Die Vervielfältigung dieses Dokuments in jeglicher Form ist ohne schriftliche Genehmigung der Dell Inc. streng untersagt.

Dell und des DELL-Logo sind Warenzeichen der Dell Inc. Dell erhebt keinerlei Eigentumsansprüche auf Warenzeichen und Namen Dritter.

November 2005

Le informazioni contenute in questo documento sono soggette a variazioni senza preavviso.
© 2005 Dell Inc. Tutti i diritti riservati.

È severamente proibita la riproduzione di qualsiasi elemento senza il permesso scritto di Dell Inc.

Dell e il logo DELL sono marchi registrati di Dell Inc. Dell non riconosce interesse di proprietà esclusiva nei marchi e nelle denominazioni di altri.

Novembre 2005

Informacje zawarte w niniejszym dokumencie mogą ulec zmianie bez uprzedzenia.
© 2005 Dell Inc. Wszystkie prawa zastrzeżone.

Powielanie niniejszego dokumentu przy użyciu jakiegokolwiek techniki bez pisemnej zgody Dell Inc. jest surowo zabronione.

Dell logo DELL to znaki towarowe firmy Dell Inc. Firma Dell nie zgłasza żadnych praw do marek i nazw innych firm.

Listopad 2005





Setting Up Your Monitor

設定您的監視器 | 安裝顯示器 | モニターのセットアップ | 모니터 설치 | การตั้งค่าหน้าจอ



CAUTION:

Before you set up and operate your Dell monitor, see the safety instructions in your monitor "Product Information Guide" See your User's Guide for a complete list of features.

注意：

設定和操作您的 Dell 顯示器前，請先參閱隨附《產品資訊指南》中的安全說明。有關顯示器功能的完整介紹也請參閱《使用指南》。

警告：

在設置和使用 Dell 顯示器之前，請參閱顯示器《產品信息指南》中的安全注意事項。此外，還請參閱用戶指南以了解全部特性。

注意：

Dell モニタをセットアップして操作する前に、モニタの“製品情報ガイド”の安全に関する注意事項をご覧ください。また、機能の完全なリストについてはユーザーズガイドをご覧ください。

주의：

Dell 모니터를 설치하고 작동하기 전에 모니터 “제품 정보 가이드”의 안전 지침을 참조하십시오. 또한, 기능의 전체 목록은 사용자 가이드를 참조하십시오.

ข้อควรระวัง:

ก่อนที่จะติดตั้งและใช้งานจอภาพเคลือบของคุณ ให้อ่านขั้นตอนเพื่อความปลอดภัยใน “คู่มือข้อมูลผลิตภัณฑ์” ของจอภาพก่อน นอกจากนี้ ให้อ่าน คู่มือผู้ใช้ ของคุณ เพื่อดูรายการคุณสมบัติที่สมบูรณ์

Dell™ 1707FP Flat Panel Monitor

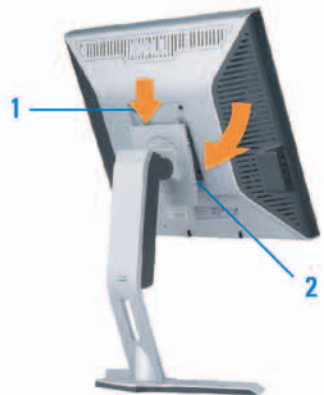

1 Attach the monitor to the stand.

將監視器裝在腳座上。
將顯示器與底座相連。
モニタをスタンドに取り付けます。
모니터를 스탠드에 부착합니다.
ต่อจอภาพเข้ากับขาตั้ง

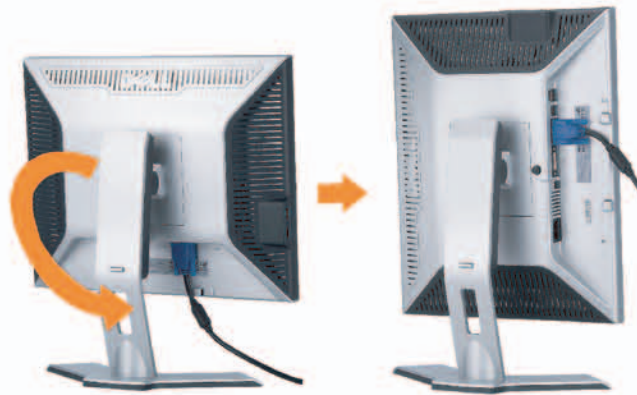

2 Rotate the monitor to connect the cables.

旋轉顯示器以便連接各連接線。
旋轉顯示器以連接線纜。
モニタを回転してケーブルを接続します。
모니터를 회전시켜 케이블을 연결합니다.
หมุนจอภาพเพื่อเชื่อมต่อสายต่างๆ

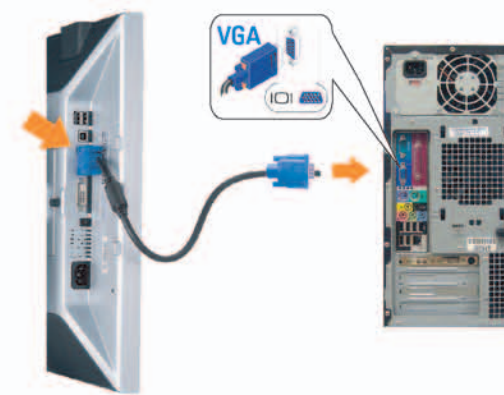

3 Connect the blue VGA cable to the computer.

將藍色 VGA 連接線連接至電腦。
將藍色 VGA 線連接到計算機。
青いVGAケーブルをコンピュータに接続します。
청색 VGA 케이블을 컴퓨터에 연결합니다.
เชื่อมต่อสายเคเบิล VGA สีฟ้าไปยังคอมพิวเตอร์

OR

或
或
または
또는
หรือ

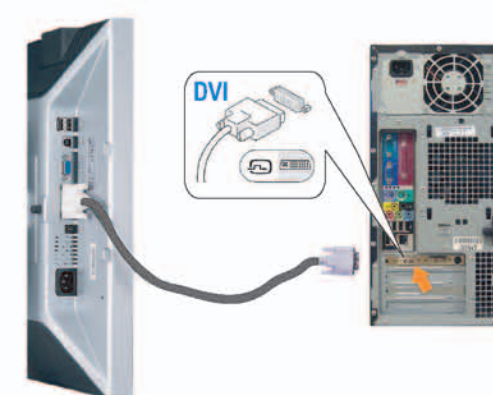

Connect the optional white DVI cable to the computer.

將選購的白色 DVI 連接線連接至電腦。
將選購的白色 DVI 線連接到計算機。
オプションの白いDVIケーブルをコンピュータに接続します。
백색 DVI 케이블(옵션)을 컴퓨터에 연결합니다.
เชื่อมต่อสายเคเบิล DVI สีขาวซึ่งเป็นอุปกรณ์เชื่อมต่อเพิ่มไปยังคอมพิวเตอร์

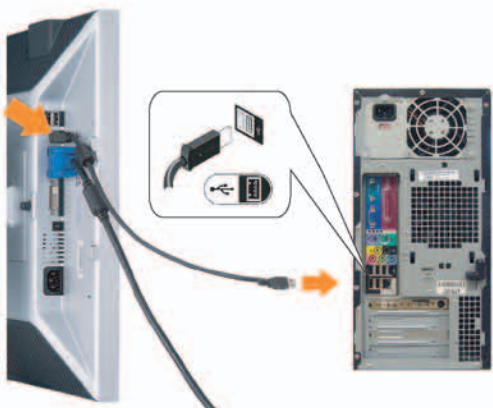

4 Connect the USB cable to the computer.

將USB纜線連接到電腦上。
將 USB 線連接到計算機。
USBケーブルコンピュータに接続します。
USB 케이블을 컴퓨터에 연결합니다.
เชื่อมต่อสายเคเบิล USB ไปยังคอมพิวเตอร์

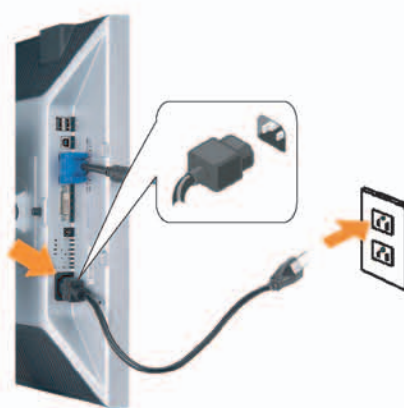

5 Connect the power cord firmly to the monitor and the electrical outlet.

將電源線確實地連接至顯示器和電源插座。
將電源線牢固插入顯示器和電源插座。
電源コードをモニタとコンセントにしっかり接続します。
전원 코드를 모니터와 전기 콘센트에 단단하게 연결합니다.
เชื่อมต่อสายไฟไปยังคอมพิวเตอร์และเต้าเสียบไฟฟ้าอย่างแน่นหนา



6 Rotate the monitor back and turn on the monitor.

將顯示器轉回原位並開啟顯示器電源。
將顯示器旋轉回原位，然後打開顯示器電源。
モニタを回転して元に戻し、モニタの電源をオンにします。
모니터를 다시 회전시킨 후 모니터를 켭니다.
หมุนจอภาพกลับ และเปิดจอภาพ



7 If nothing appears on the screen, press the Input Select button.

若螢幕沒顯示畫面，請按“輸入選擇”按鈕。
如果屏幕上無顯示，請按“輸入選擇”按鈕。
画面に何も表示されない場合、「入力選択」ボタンを押してください。
화면에 아무것도 나타나지 않으면 [입력 선택] 버튼을 누릅니다.
ถ้าไม่มีอะไรปรากฏขึ้นบนหน้าจอ ให้กดปุ่ม Input Select (เลือกสัญญาณเข้า)



7730203295P0A

www.dell.com | support.dell.com



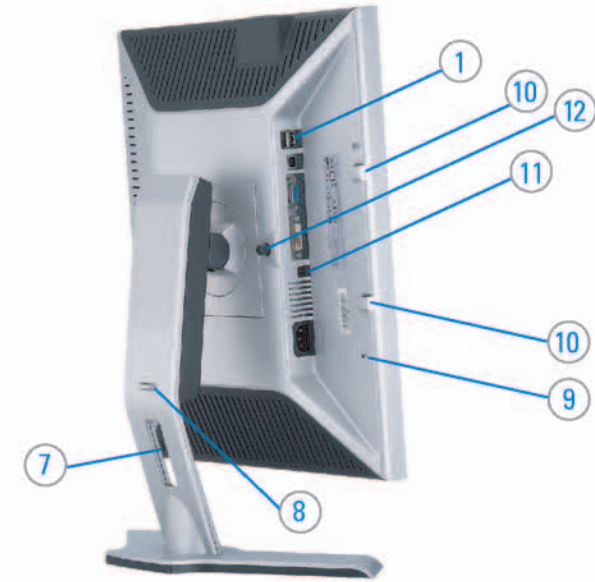
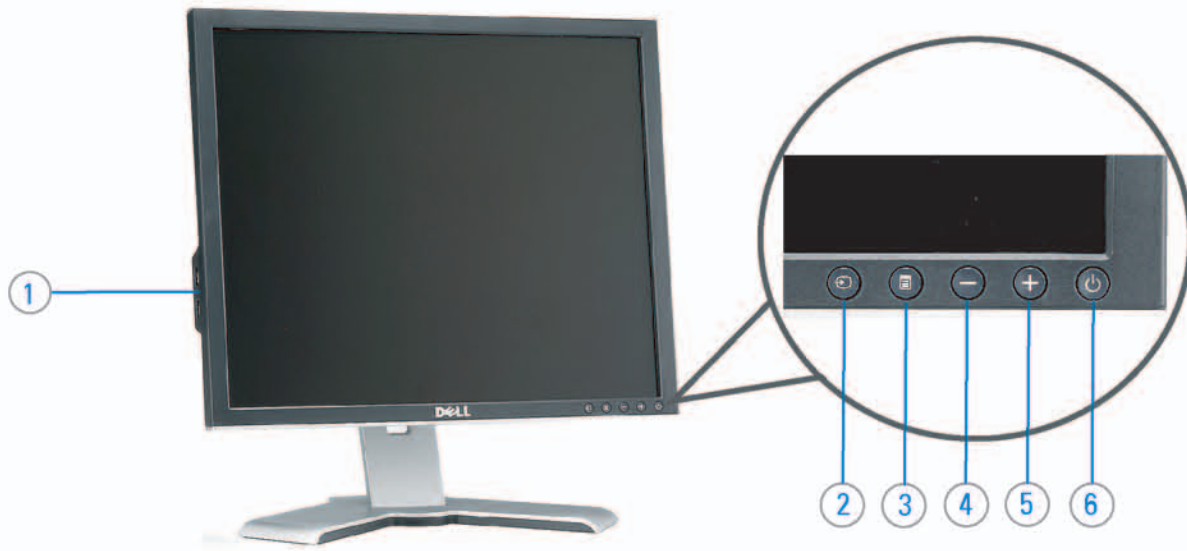

- 1. USB downstream port
- 2. Video Input Select
- 3. OSD Menu/Select
- 4. DOWN
- 5. Up
- 6. Power button (with power light indicator)
- 7. Cable management hole
- 8. Lock down/release button
- 9. Security lock slot
- 10. Dell Soundbar mounting brackets
- 11. Power Out for Dell Soundbar
- 12. Monitor Lock/Release Button

- 1. USB 下游連接埠
- 2. 影像輸入選擇
- 3. OSD 功能表/選擇
- 4. 下
- 5. 上
- 6. 電源按鈕 (帶有電源指示燈)
- 7. 纜線理線孔
- 8. 鎖定/釋放按鈕
- 9. 安全鎖插槽
- 10. Dell Soundbar 勾槽托架
- 11. Dell Soundbar 電源輸出
- 12. 銀幕鎖定/鬆開按鈕

- 1. USB 下行端口
- 2. 視頻輸入選擇
- 3. OSD 菜單/選擇
- 4. 向下
- 5. 向上
- 6. 電源按鈕 (帶電源指示燈)
- 7. 纜線管理孔
- 8. 鎖按下/鬆開按鈕
- 9. 防盜鎖插槽
- 10. Dell Soundbar 安裝架
- 11. Dell Soundbar 電源輸出
- 12. 銀幕鎖定/釋放按鈕

- 1. USBダウンストリームポート
- 2. ビデオ入力選択
- 3. OSDメニュー/選択
- 4. 下
- 5. 上
- 6. 電源ボタン (電源ライトインジケータ付き)
- 7. ケーブル管理ホール
- 8. ロックダウン/リリースボタン
- 9. セキュリティロックスロット
- 10. Dell サウンドバー取付ブラケット
- 11. Dell Soundbar 用の電源コネクタ
- 12. パネルロック/リリースボタン

- 1. USB 다운스트림 포트
- 2. 비디오 입력 선택
- 3. OSD메뉴/선택
- 4. 아래로
- 5. 위로
- 6. 전원 버튼 (전원 표시등)
- 7. 케이블 관리 구멍
- 8. 잠금/해제 버튼
- 9. 도난 방지 장치 슬롯
- 10. Dell Soundbar 설치 브래킷
- 11. Dell Soundbar 전원 출력
- 12. 패널 잠금/잠금 해제 버튼

- 1. พอร์ตดาวน์โหลด USB
- 2. เลือกสัญญาณภาพเข้า
- 3. เมนู OSD /เลือก
- 4. ลง
- 5. ขึ้น
- 6. ปุ่มเพาเวอร์ (พร้อมไฟแสดงสถานะเพาเวอร์)
- 7. รูสำหรับจัดระเบียบสายเคเบิล
- 8. ปุ่มล็อค/คลาย
- 9. ล็อคเคนซิงค์
- 10. ที่ติดแถบเสียง Dell
- 11. ไฟไฟเข้าแถบเสียง Dell
- 12. ปุ่มล็อค/ปลดล็อคแผ่นจอ



Finding Information

See your monitor *User's Guide* in the CD, for more information.

尋找資訊

詳細資訊請參閱光碟中的顯示器《使用指南》。

查找信息

有关的详细信息, 请参阅光盘中的显示器用户指南。

検索情報

詳細については、CDのモニターユーザーガイドをご覧ください。

정보 찾기

더 자세한 정보는 CD에 포함된 모니터 사용자 가이드를 참조하십시오.

การค้นหาคำข้อมูล

สำหรับข้อมูลเพิ่มเติมให้อ่าน คู่มือผู้ใช้ในแผ่นซีดี

Information in this document is subject to change without notice.
© 2005 Dell Inc. All rights reserved.

Reproduction in any manner whatsoever without the written permission of Dell Inc. is strictly forbidden.

Dell and the DELL logo are trademarks of Dell Inc. Dell disclaims proprietary interest in the marks and names of others.

November 2005

本指南的內容如有變更, 恕不另行通知。
© 2005 Dell Inc. 版權所有。

未經 Dell Inc. 的書面許可, 嚴禁任何形式的非法複製。

Dell 及 DELL 標誌為 Dell Inc. 的商標。其他標誌和名稱的所有權皆不屬 Dell 所有。

2005年11月

本指南的內容如有變更, 恕不另行通知。
© 2005 Dell Inc. 版權所有。

未經 Dell Inc. 的書面許可, 嚴禁任何形式的非法複製。

Dell 和 DELL 標誌是 Dell Inc. 的商標。Dell 對非 Dell 公司的商標和商標名稱的所有權。

2005年11月

本書に記載されている事項は事前通告無しに変更されることがあります。
© 2005 すべての特許権は Dell Inc. にあります。

Dell Inc. からの書面による許可なく本書の複写、転載を禁じます。

Dell と DELL のロゴマークは、Dell Inc. の登録商標です。上記記載以外の商標や会社名が使用されている場合がありますが、これらの商標や会社名は、一切 Dell Inc. に所属するものではありません。

2005年11月

이 안내서에 있는 내용은 사전 통보 없이 변경될 수 있습니다.
© 2005 Dell Inc. 모든 권리 소유.

Dell Inc. 의 서면 승인 없이 재작성 또는 복제 행위는 일격히 금지합니다.

Dell 과 Dell 로고는 Dell Inc. 의 등록상표입니다. Dell 은 자사 이외의 상표 및 상품명에 대해서는 어떤 소유권도 인정하지 않습니다.

2005년11월

เนื้อหาของผู้จัดทำฉบับนี้ อาจเปลี่ยนแปลงได้ โดยไม่แจ้งก่อนล่วงหน้า
© 2005 Dell Inc. สงวนลิขสิทธิ์

ห้ามผลิตหรือดัดแปลงเนื้อหาฉบับนี้โดยไม่ได้รับอนุญาตจากบริษัท เดลล์ คอร์ปอเรชั่น

Dell และโลโก้ Dell เป็นเครื่องหมายการค้าของบริษัทเดลล์คอมพิวเตอร์ บริษัทเดลล์ไอออนูมาตรี การบริการเชิงธุรกิจและเครื่องหมายการค้าที่เขียนไว้

พฤศจิกายน 2005

